

# Model AD1024 MegaPower II Matrix Switching Bays

## Installation and Operating Instructions

This manual describes the installation and operating procedures for the American Dynamics model AD1024 Matrix Switching System Bays. The AD1024 MegaPower II is designed as an integrated matrix switching and control system for CCTV surveillance systems having multiple cameras, multiple monitors, and multiple control stations. The AD1024 Systems consist of a matrix switching bay, its power supply module, a data receiver/buffer module, the required video input modules (VIM), video output modules (VOM), and appropriate rear panels.



This software/firmware is confidential to and is copyrighted by SENSORMATIC ELECTRONICS CORPORATION. It is not to be copied or disclosed in any manner without the express written consent of SENSORMATIC. The software is furnished to the purchaser under a license for use on a single system.

NOTE: Information furnished by SENSORMATIC is believed to be accurate and reliable. However, no responsibility is assumed by SENSORMATIC for its use; nor for any infringements of other rights of third parties which may result from its use. No license is granted by implications or otherwise under any patent or patent rights of SENSORMATIC.

Copyright 1999 by SENSORMATIC. All rights reserved.

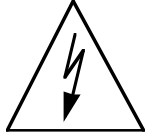

The installation of this product should be made by qualified service personnel and should conform to all local codes.

	<b>CAUTION</b> RISK OF ELECTRIC SHOCK DO NOT OPEN	
<p>CAUTION: TO REDUCE THE RISK OF ELECTRIC SHOCK, DO NOT REMOVE COVERS (OR BACK) . NO USER-SERVICEABLE PARTS INSIDE. REFER SERVICING TO QUALIFIED SERVICE PERSONNEL</p>		

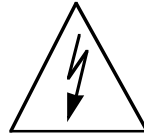

The lightning flash with arrowhead symbol, within an equilateral triangle, is intended to alert the user to the presence of uninsulated "dangerous voltage" within the product's enclosure that may be of sufficient magnitude to constitute a risk of electric shock to persons.



The exclamation point within an equilateral triangle is intended to alert the user to the presence of important operating and maintenance (servicing) instructions in the literature accompanying the product.

<b>WARNING</b> To reduce the risk of fire or shock hazard, do not expose this product to rain or moisture.
---

### UNPACKING AND INSPECTION

Unpack carefully. This is an electronic product and should be handled as such. Compare the items received with the packing list with your order.

Be sure to save:

1. The shipping cartons and insert pieces. They are the safest material in which to make future shipments of the product.
2. The IMPORTANT SAFEGUARDS sheet.
3. These Installation and Operating Instructions.

This equipment has been tested and found to comply with Part 15 of the FCC Rules.

Operation is subject to the following two conditions: 1. This device may not cause harmful interference, and 2. This device must accept any interference received, including interference that may cause undesired operation.

### MAINTENANCE

User maintenance of this unit is limited to external cleaning and inspection. For specific recommendations refer to the IMPORTANT SAFEGUARDS sheet packaged with this product.

### INSTALLATION AND SERVICE

If you require information during installation of this product or if service seems necessary, contact the Sensormatic Repair and Service Department at (800) 442-2225. You must obtain a Return Authorization Number and shipping instructions before returning any product for service.

Do not attempt to service this product yourself. Opening or removing covers may expose you to dangerous voltages or other hazards. Refer all servicing to qualified personnel.



# CONTENTS

	<b>Page</b>
General Description .....	1
System Modules Description	
Power Supply Module 2010PS .....	2
Data Buffer Module 2010DB.....	4
Video Loss Detection Data Buffer 2010DBVL .....	6
Video Input Module 2016AVIM.....	8
Video Output Module 2024VOM .....	9
Master Date Time Module 2024MDT .....	10
Installation	
Power Sources.....	11
Mounting .....	11
Connections.....	11
Setup	
Data Buffer Module .....	12
Video Loss Detector Data Buffer.....	13
Video Input Module .....	14
Video Output Module .....	16
Power Supply Module.....	18
Powering Up	
Powering the Matrix Bay .....	19

# CONTENTS

	<b>Page</b>
System Configurations	
Level 1 Systems	
Level 1 - 256 X 16, One Bay with No Titles .....	20
Level 1 - 192 X 16, One Bay System .....	21
Level 1 - 448 X 16, Two Bay System.....	22
Level 1 - 704 X 16, Three Bay System.....	23
Level 1 - 960 X 16, Four Bay System .....	24
Level 1 - 1024 X 16, Five Bay System.....	25
Level 2 Systems	
Level 2 - 64 X 32, One Bay System .....	27
Level 2 - 192 X 32, Two Bay System.....	28
Level 2 - 320 X 32, Three Bay System.....	29
Level 2 - 448 X 32, Four Bay System .....	30
Level 2 - 704 X 32, Six Bay System.....	31
Level 2 - 960 X 32, Eight Bay System .....	32
Level 2 - 1024 X 32, Nine Bay System .....	34
Level 3 Systems	
Level 3 - 192 X 48, Three Bay System.....	36
Level 3 - 256 X 48, Four Bay System .....	37
Level 3 - 448 X 48, Six Bay System.....	38
Level 3 - 512 X 48, Seven Bay System .....	39
Level 3 - 704 X 48, Nine Bay System .....	40
Level 3 - 768 X 48, Ten Bay System .....	42
Level 3 - 960 X 48, Twelve Bay System .....	44
Level 3 - 1024 X 48, Fourteen Bay System.....	46
ADULP Looping Panel.....	48
Appendix	
Level 1 Interconnect Drawings.....	A1 - A5
Level 2 Interconnect Drawings.....	A6 - A11
Level 3 Interconnect Drawings.....	A12 - A16
Level 8 Interconnect Drawings .....	A17
Video Loss Detector Connections.....	A18 - A21
Video Buffer Interconnection.....	A22

**GENERAL DESCRIPTION**

The MegaPower II AD1024 Switcher/Control System is an integrated matrix switching and control system for CCTV surveillance systems. It is capable of controlling up to 1024 video input sources such as cameras, and 128 video outputs such as monitors and video tape recorders.

The AD1024 system consists of a matrix switching bay, its power supply module, a data receiver/buffer module, the required video input modules (VIM), video output modules (VOM), and appropriate rear panels. All AD1024 systems are controlled with a separate central processing unit (CPU) and keyboard.

AD1024 Switcher/Control Systems are supplied as completely configured switching bays. Only the bay interconnections, the CPU connections, the video input and output connections, and any optional accessory connections need be made prior to operation. The AD1024 system, as delivered, is a complete system with all inputs terminated in 75 ohms. Each bay is packed in a separate shipping carton labeled with the AD1024 bay assembly number on the outside of the carton.

**Matrix Switching Bay**

The 2010R and 2020R switching bays include the physical chassis, a back plane, a power supply module, and a data receiver. Each bay has the capability of looping the DATA LINE input and looping an external vertical synchronization pulse to other bays. Each bay also accommodates a combination of video input modules and video output modules, up to a total of 16 modules.

Power: 50 watts (full system)  
 Size: 10-1/2" height. Full-width 19" rack mount  
 Weight: 60 lbs. (28 kg) (full system)

**CPU (Central Processing Unit)**

The CPU for the AD1024 system is a separate rack-mounted unit that includes its own power supply, system software, ten RS-232 ports, a system diagnostic monitor output, and two DATA LINE outputs. These DATA LINE outputs distribute high speed data control signals to the AD1024 matrix switching bays and optional accessories.

**AD1024 Central Processing Unit**

Power: 4 watts  
 Size: 1.75" height. Full-width 19" rack mount  
 Weight: 10 lbs. (4.5 kg)

**OPTIONAL EQUIPMENT**

The following separate units may be connected to the AD1024 system for added capabilities. For specific information, refer to the respective data sheets.

**2091 Control Code Generator/Distributor**

The 2091 provides 64 control-code outputs for control of 1640 and 1680 Series Receivers actuating pan/tilt; lens zoom, focus, and iris; and auxiliaries at suitably-equipped camera sites.

**2031 Switcher/Follower,  
 2032 Alarm Responder,  
 2033 Auxiliary Follower**

The 2030 Series Followers switch external circuits when designated cameras are called to designated monitors (2031), when designated monitors are in alarm conditions (2032), or when designated auxiliaries are called up or designated cameras are alarmed (2033).

**ADULP Looping Panel**

The ADULP Looping Panel is used to facilitate the looping of video signals for the AD1024 system from external inputs or to external devices such as time-lapse video recorders, switchers, monitors, etc.

**Other Switcher/Control System Accessories**

- 1640 and 1680 Series Receivers
- 1670 and 2078 Series Keyboards
- 1680MG Manchester Generator
- 1683 Control Code/PSK Modem
- 1981 Port Expander
- 2081 Port Expander
- 1983 Code Converter
- 2083 Code Translators
- 2096 Alarm Interface Unit
- 1985A Hot Switch

**IF YOU ENCOUNTER ANY PROBLEMS  
 OPERATING THIS UNIT, OR NEED ASSISTANCE,  
 CALL OUR TECHNICAL SUPPORT CENTER AT:**

within the United States: **1-800-442-2225**  
 outside the United States: **(845) 624-7600**

This installation should be made by qualified service personnel and should conform to all local codes. Safeguards must be taken to avoid unintentional operation by employees and maintenance personnel working about the premises, by falling objects, by customers, by building vibration, and by similar causes.

## SYSTEM MODULES DESCRIPTION

### SYSTEM MODULES

The following pages describe the plug-in modules available for AD1024 switching bays. These include:

Power Supply Module, 2010PS  
Data Buffer Module, 2010DB  
Video Loss Detection Data Buffer Module, 2010DBVL  
Video Input Module, 2016AVIM  
Video Output Module, 2024VOM  
Master Date Time Module, 2024MDT

#### Power Supply Module - 2010PS

The power supply module for the matrix switching bay converts AC power to the necessary DC voltages which are supplied to all the modules in the switching bay.

#### Front Panel

Figure 1 illustrates the features described below.

- 1- SYNC TEST ON/OFF LED:** This red LED is illuminated when the SET UP/NORMAL switch (below) is in the SET UP position.
- 2- SET UP/NORMAL SWITCH:** When set to the SET UP position, this switch implements sync test and adjustment. (See Power Supply Setup, page 18.)
- 3- SYNC LOSS LED:** This red LED is off if video sync is locked. When illuminated, it indicates that sync is not locked due either to a poor sync signal, no sync signal, or the wrong sync signal (as determined by the setting of the sync selection switch below).
- 4- SYNC REFERENCE SELECTION SWITCH:** This switch selects one of three video sync references:
  - EXT V-DRIVE (Up position): Selects the external vertical drive pulse input on the rear panel (EXT SYNC IN).
  - EXT CAM (Center position): Selects composite video.
  - AC LINE (Down position): Selects the AC line (as supplied).
- 5- SYNC PHASE ADJUSTMENT:** This potentiometer, accessed thru the hole in the front panel of the Power Supply, adjusts the phase of the sync pulse with respect to the selected reference. When the sync test switch is set to SET UP, a horizontal trace line is displayed on Monitor 1, showing the location of the sync pulse with respect to the picture. (See Power Supply Setup, page 18.)
- 6- +9 VDC AND -9 VDC LED's:** These green LED's, when illuminated, indicate the presence of DC voltages (Note: For the 230 VAC systems, the output voltages are +/-8 VDC).
- 7- POWER ON/OFF SWITCH:** This switch is used to apply power to the bay. When the switch is in the ON position, a green light is illuminated behind the Power On/Off Switch.

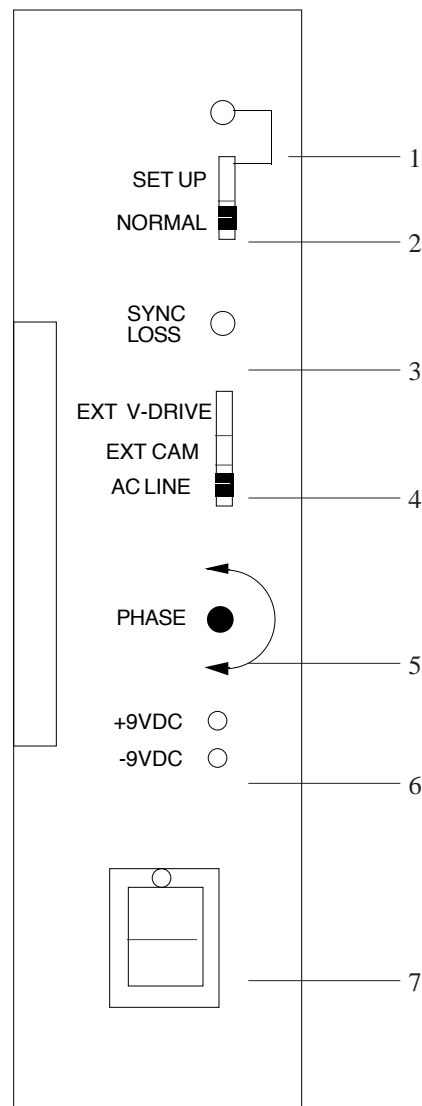

Figure 1 - Front Panel of Power Supply Module

**Fusing:** Four replaceable fuses are located on the power supply circuit board. Replacement fuses must meet national and local use code requirements.

#### Fuse Ratings:

##### For 120VAC Systems:

- F1: 125V, 5 AMP, 5 x 20 mm
- F2: 125V, 5 AMP, 5 x 20 mm
- F3: 250V, SB, 0.5 AMP, 5 x 20 mm, UL listed
- F4: 250V, SB, 0.5 AMP, 5 x 20 mm, UL listed

##### For 230VAC CE Compliant Systems:

- F1: 250V, T, 3.15 AMP, 5 x 20 mm
- F2: 250V, T, 3.15 AMP, 5 x 20 mm

##### For 230VAC Non-CE Compliant Systems:

- F1: 125V, 5 AMP, 5 x 20 mm
- F2: 125V, 5 AMP, 5 x 20 mm
- F3: 250V, T, 0.25 AMP, 5 x 20 mm
- F4: 250V, T, 0.25 AMP, 5 x 20 mm



**Power Supply Module - Rear Panel**

Figure 2 is the illustration associated with the features described below.

- 8- **SERIAL # TAG:** Serial number assigned to this AD1024 switching bay.
- 9- **DATA LINE IN:** Input for DATA LINE.
- 10- **DATA LINE OUT:** Looping output for DATA LINE. This line must be terminated with a 75-ohm terminator.
- 11- **EXTERNAL SYNC IN:** Input for external vertical synchronous pulse, either camera sync or an externally created sync pulse.
- 12- **EXTERNAL SYNC OUT:** Looping output for EXT SYNC. This line must be terminated with a 75-ohm terminator.

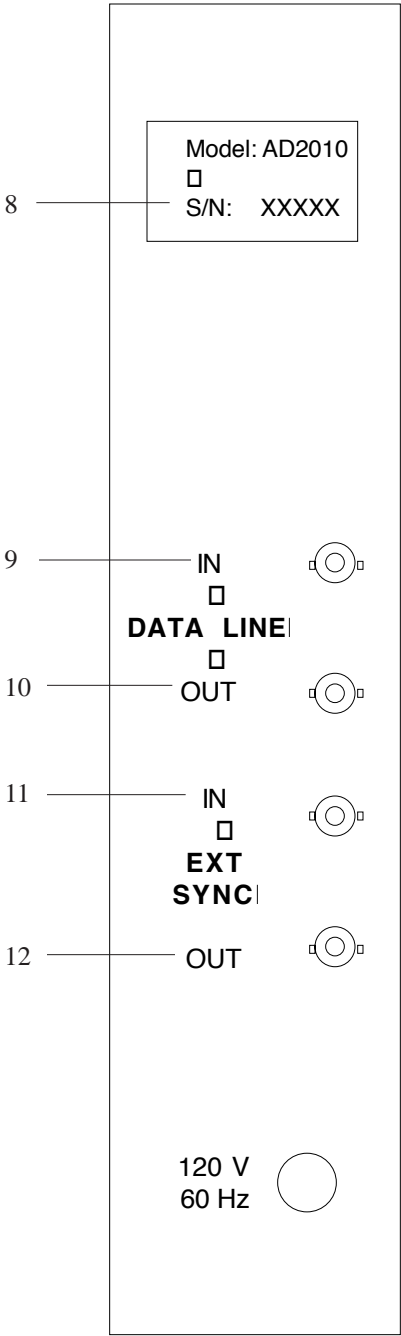

Figure 2 - Rear Panel of Power Supply Module

**SYSTEM MODULES DESCRIPTION**

**Data Buffer Module - 2010DB**





The Data Buffer Module serves a dual purpose. First, it distributes switched video, from the bay's Video Input Modules, to other bays in multiple bay systems. The video observed from these outputs contain no character information, only standard video.

The second purpose of the Data Buffer is to filter incoming system information from the DATA LINE. Filtering is performed to allow for the passage of localized information.

The 2010DB rear panel has 16 video output BNC's for connection to Video Output Modules in other switching bays. The illustrations in Figures 3 through 8 show the various types of rear panels of the Data Buffer module.

See Appendix Figure A22 for illustration of interconnection from these modules to the Video Output Modules.

**Icon Definition:** The  is the video/interconnect symbol for connecting switched video among the matrix switching bays.

-  Switched video inputs from cameras 1 to 256.
-  Switched video inputs from cameras 257 to 512.
-  Switched video inputs from cameras 513 to 768.
-  Switched video inputs from cameras 769 to 1024.

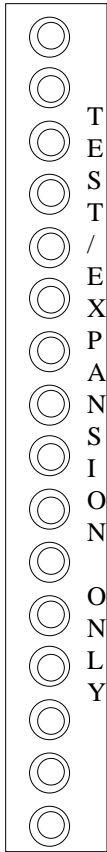

Figure 3  
2010DB-00  
Rear Panel

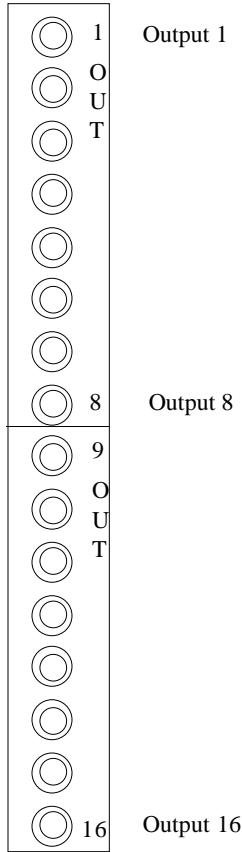

Figure 4  
2010DB-01  
Rear Panel w/ 16 BNCs  
Camera Card Bay  
(No Monitor Modules)

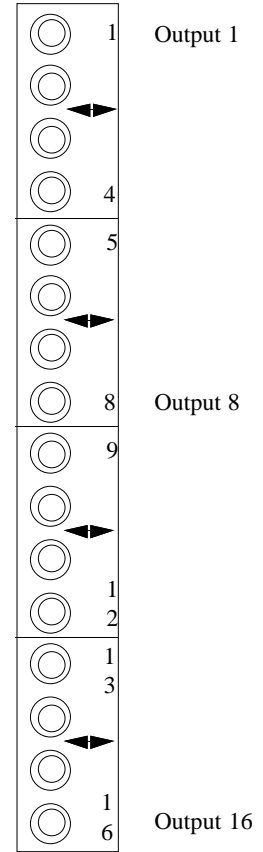

Figure 5  
2010DB-11 to 2010DB- 18  
Rear Panel w/ 16 BNCs  
Multiple-Bay System  
for cameras 1-256

Data Buffer Module - 2010DB (continued)

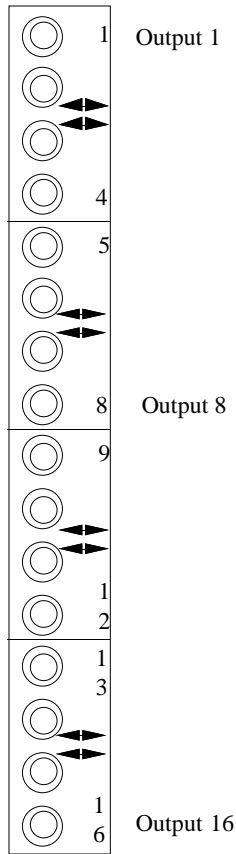

Figure 6  
2010DB-21 to 2010DB-28  
Rear Panel w/ 16 BNCs  
Multiple-Bay System  
for cameras 257-512

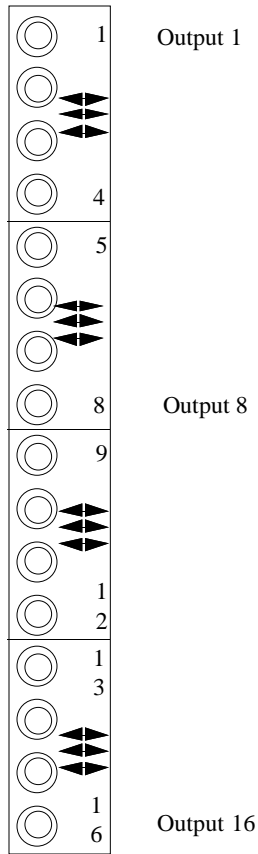

Figure 7  
2010DB-31 to 2010DB-38  
Rear Panel w/ 16 BNCs  
Multiple-Bay System  
for cameras 513-768

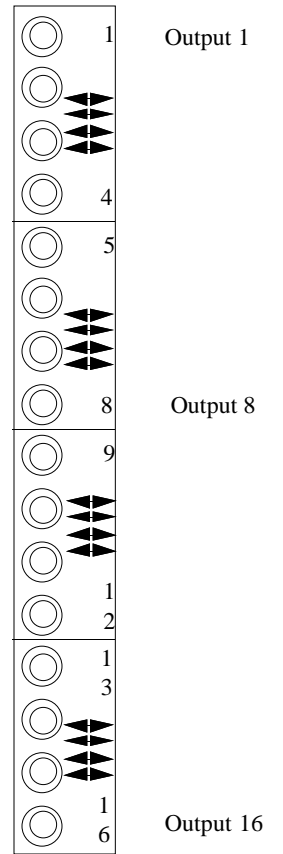

Figure 8  
2010DB-41 to 2010DB-48  
Rear Panel w/ 16 BNCs  
Multiple-Bay System  
for cameras 769-1024

**SYSTEM MODULES DESCRIPTION**

**Video Loss Detection Data Buffer Module - 2010DBVL**

The Video Loss Detector Data Buffer Module provides the same capabilities as the 2010DB Data Buffer Module, with one significant addition. First, it distributes switched input video, with no character information, to multiple bay systems. It also filters incoming information from the DATA LINE to allow for the passage of localized information.

The additional function of this module is to detect the presence of a video signal for each camera input. Each module can detect video loss for a maximum of 256 cameras. For a full matrix switching system of 1024 cameras, four 2010DBVL modules are required, one for each block of 256 cameras.

The 2010DBVL module must be placed in the matrix switching bay that is connected to the highest numbered monitor output, and this bay must contain Video Input Modules. The 2010DBVL cannot be used in a switching bay that does not include Video Input Modules.

**Front Panel**

The front panel of the 2010DBVL provides indicator LED's that illuminate if a video or sync loss is detected, and indicate the SYNC and VIDEO content of the video input signal being monitored. See Figure 9 for location of these LED's.

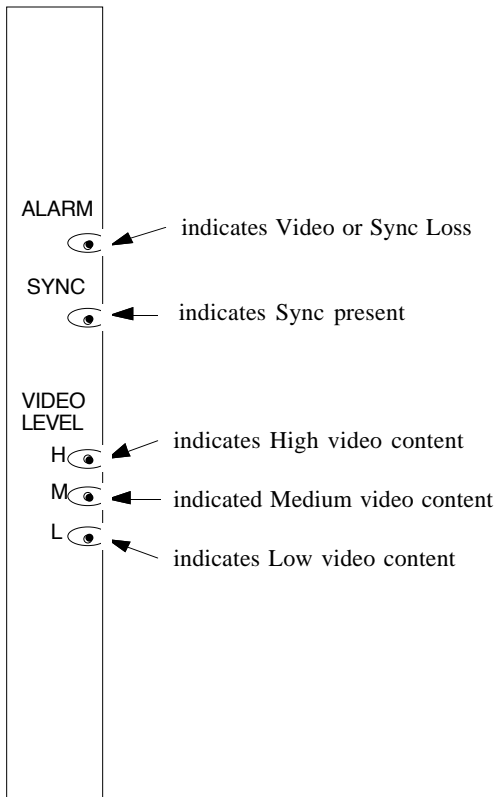







Figure 9  
2010DBVL Front Panel LED Indicators

**Rear Panels**

The 2010DBVL rear panel has 15 video output BNC's for connection to Video Output Modules, and one 8-pin, RJ45 RS-232 connector for Video Loss Detection data output and Alarm Contact output to an Alarm Interface Unit. Figures 9 through 15 show the various types of rear panels of the Video Loss Detector Data Buffer module.

**Icon Definition:** The  icons on the rear panels are the video/interconnect symbol for connecting switched video among the matrix switching bays.

-  Switched video inputs from cameras 1 to 256.
-  Switched video inputs from cameras 257 to 512.
-  Switched video inputs from cameras 513 to 768.
-  Switched video inputs from cameras 769 to 1024.

See Appendix Figure A22 for illustration of interconnection from these modules to the Video Output Modules.



Figure 10  
2010DBVL-00 Rear Panel

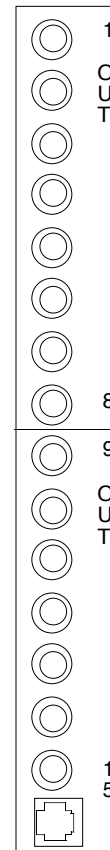

Figure 11  
2010DBVL-01 Rear Panel  
Camera Card Bay  
(No Monitor Modules)

When a video loss is detected, a video loss message is transmitted from the 2010DBVL via the RJ45 connector RS-232 pins. An alarm contact is also provided by pins 1 and 2 of this connector. The connector pin definitions are as follows.

RJ45 Connector Pin Definitions

Pin	Function (RS-232 Code)
1	Alarm Contact Output
2	Alarm Ground
4	Receive Data (RCD)
5	Transmit Data (XMIT)
7	Ground (GND)

The RS-232 pins are connected to an RS-232 port, on the AD1024 CPU, which is set for VIDEO LOSS use. The RS-232 port can be connected using the supplied modular cable. If the distance between the 2010DBVL and the CPU is less than 7 feet.

If the distance exceeds 7 feet, or if the Alarm Contact output is used, an 8-pin Terminal Box is provided for connections. The Terminal Box is connected to the 2010DBVL RS-232 port with the supplied modular cable. The maximum cable length between an RS-232 device and the Terminal Box is 1000 feet, using 18-AWG shielded, computer grade cable.

All American Dynamics equipment is configured as RS-232 DTE (Data Terminal Equipment) devices. For DTE-to-DTE connection to the 2010DBVL Terminal Box:

- the XMIT pin of the 1996 port is connected to RCD (pin 4) of the 2010DBVL Terminal Box.
- the RCD pin of the 1996 port is connected to XMIT (pin 5) of the 2010DBVL Terminal Box.
- the Ground of the 1996 port is connected to GND (pin 7) of the 2010DBVL Terminal Box.

Pins 1 and 2 provide a logic-level alarm closure, in accordance with the Alarm Contact mode set for the module (see page 13). These pins are connected to the alarm contact inputs of a 2096 Alarm Interface Unit, pin 1 to "A" input and pin 2 to ground.

Where multiple 2010DBVL modules are used, 1981 or 2081 port expanders are used to connect these modules to the AD1024 CPU. The 2010DBVL-1x module must be connected to port A of the 1981, 2010DBVL-2x to port B, 2010DBVL-3x to port C, and 2010DBVL-4x to port D. Video loss detection will not operate unless all modules are connected to the AD1024 CPU.

Typical connections of the 2010DBVL module are illustrated in the Appendix, Figures A18 to A21.

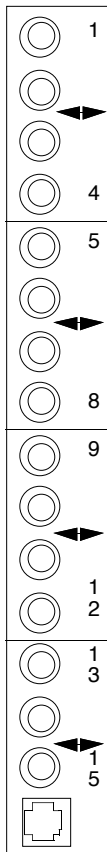

Figure 12  
2010DBVL-11 to -18  
Multiple-Bay System  
for cameras 1-256

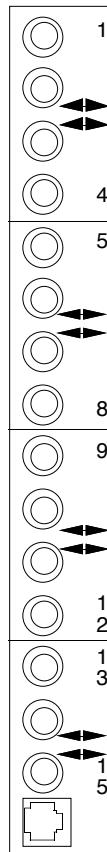

Figure 13  
2010DBVL-21 to -28  
Multiple-Bay System  
for cameras 257-512

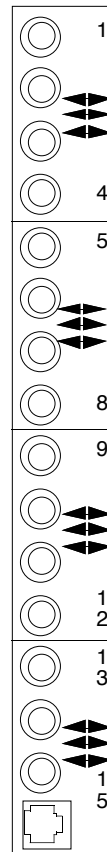

Figure 14  
2010DBVL-31 to -38  
Multiple-Bay System  
for cameras 513-768

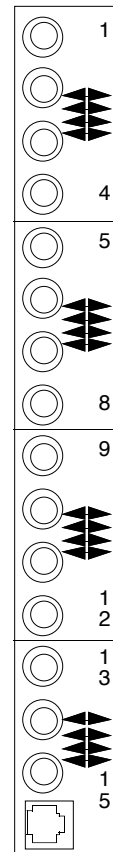

Figure 15  
2010DBVL-41 to -48  
Multiple-Bay System  
for cameras 769-1024

**Video Input Modules - 2016AVIM**

The 2016AVIM performs the actual video switching in the AD1024 switching bay. Each module can switch any one of 16 video inputs to any video output, or multiple combinations of video outputs, up to 16. The 16 video inputs to the module are connected at the rear panel associated with the video input module. The switched video outputs are provided to the Video Output Modules and the Data Buffer Module in the bay.

There are four different types of rear panels, shown below.

**Icon Definition:** The following icon denotes video inputs.



The 2016AVIM-1, as seen in Figure 16, has 16 BNC connectors for video inputs. The number next to each BNC reflects the actual input numbers.

The 2016AVIM-2, as seen in Figure 17, has eight BNC connectors for the upper group of eight video inputs and one 34-pin connector. The number next to the BNC reflects the actual input numbers.

The third rear panel, 2016AVIM-3, as seen in Figure 18, has eight BNC connectors for the lower group of eight cameras to complete the larger group of 16 video inputs and two 34-pin connectors.

The fourth type of rear panel, 2016AVIM-4, as seen in Figure 19, has only two 34-pin connectors. They are used for expansion in multiple switching bay configurations.

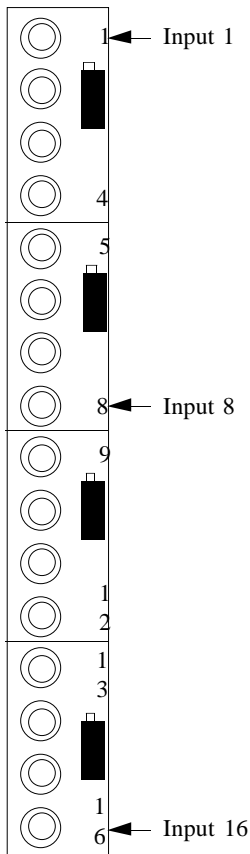

Figure 16  
2016AVIM-1

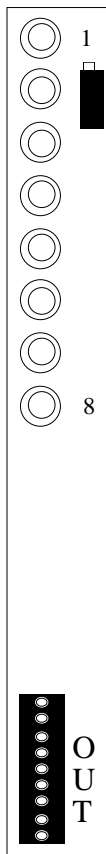

Figure 17  
2016AVIM-2

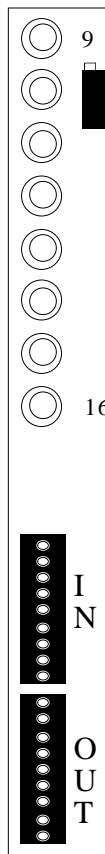

Figure 18  
2016AVIM-3

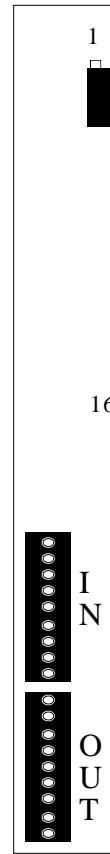

Figure 19  
2016AVIM-4

**Video Output Module - 2024VOM**

The 2024VOM (Video Output Module) creates the titles that are added to the video output. Each module has four video outputs on its rear panel.

**Front Panel**

Front panel controls on the Video Output Module adjust the brightness, vertical, and horizontal position for each title displayed on each of the four video outputs. The 4-position rotary switch on the front panel governs which output you control. The front panel LED blinks to verify proper operation of the 2024VOM. See Figure 20 below. Further details on operation of these controls is provided in the Video Output Module SETUP description, page 17.

**Rear Panels**

The 2024VOM-1 rear panel, as seen in Figure 21, has 16 BNC connectors. The bottom four BNCs are video outputs while the remaining upper three groups, each containing four BNCs, are for video inputs from other matrix switching bays in the system.

The 2024VOM-2 rear panel, as seen in Figure 22, has four sections of four BNCs for video inputs from other matrix switching bays. A fifth section of four BNCs, in the lower left corner, is used for video outputs.

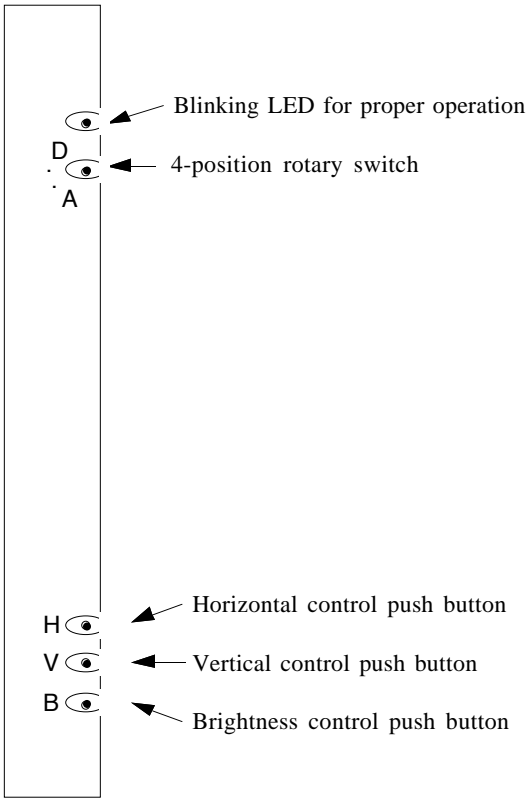

Figure 20  
Video Output Module  
Front Panel Indicators and Controls

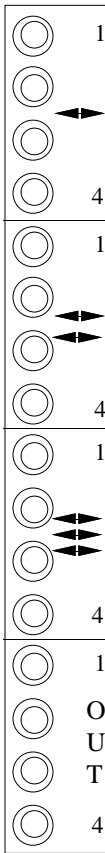

Figure 21  
Video Output Module  
2024VOM-1  
Rear Panel

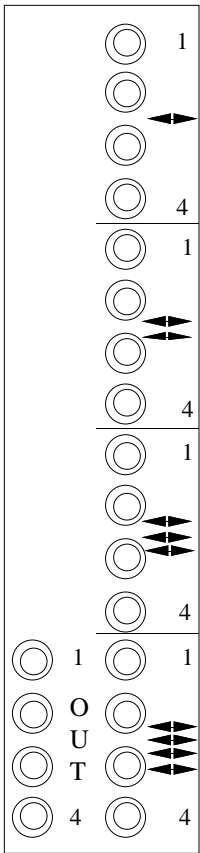

Figure 22  
Video Output Module  
2024VOM-2  
Rear Panel

## SYSTEM MODULES DESCRIPTION

### Master Date Time Module - 2024MDT

The 2024MDT Master Date Time Module provides looping connection of the video input signals and insertion of system time and date information on the video output connections. These modules are used with dedicated inputs for dedicated outputs, and do not perform any inter-bay switching.

The 2024MDT has four looping video inputs and four separate video outputs with system time and date information.

#### Front Panel

The 2024MDT front panel controls the brightness, vertical, and horizontal position for each title displayed on each of the four video outputs. The 4-position rotary switch governs which output is selected for control. The LED blinks to verify proper operation of the 2024MDT. The front panel controls operate identical to those on the 2024VOM module, see Figure 20 on page 9. Further details on operation of these controls is provided in the Video Output Module SETUP description, page 17.

#### Rear Panels

The 2024MDT rear panel, shown in Figure 23, has 12 BNC connectors and handles four separate video input channels: A, B, C, and D. The bottom four BNC's are video outputs which contain time and date information from the system Data Line interface. The upper four groups of BNC's are for video inputs from matrix switching bays and looping outputs to other video equipment, such as VCR's. Each BNC pair in the upper groups is an unterminated looping connection.

Video inputs to the 2024MDT module may be connected to either of the input pair of BNC's for each input channel. If the video is terminated in the 2024 module, and not looped to additional equipment via the paired BNC, a 75-ohm terminating cap must be connected to the paired input BNC. 75-ohm terminating caps are supplied for the looping BNC connectors.

If any video input is looped to another video device, ensure that the line is terminated properly in 75 ohms.

The video output connections from the bottom four BNC's on each 2024 module must be terminated in 75 ohms.

#### Setup Switches

The 2024MDT module PCB card contains jumpers that are set to identify the monitors that the video output is being directed to. These are factory set for monitors one, two, three, and four.

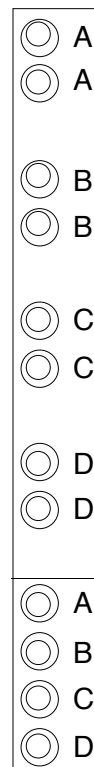

Figure 23  
2024MDT Rear Panel

4 channels, looping inputs  
4 channels, outputs



**INSTALLATION**

**Mounting**

Bays are manufactured for standard 19-inch rack mounting and have a rack height of 10 1/2-inches, or one rack wide by 6 racks high. Bays must be installed with a minimum of 1 3/4-inch clearance between each bay (one rack unit). It is the responsibility of the installer to insure proper airflow around the bays to provide adequate ventilation.

In multiple bay configurations, identify the various bays carefully before mounting. In all multiple bay systems, place the video inputs near the top of the racks.

**Power Sources**

System model AD1024R is configured for use with a 120VAC, 50/60 Hz primary power source. Model ADS1024RX is configured for a 230VAC, 50/60 Hz primary power source. All 120 V units are supplied with a pendant, 3-wire cord and plug for mating to the primary source outlet. All 230 V units are supplied with a Euro style IEC type inlet. A suitable detachable cord should be connected between the IEC 320 inlet and the power source. The cord should conform to all national and local use code requirements.

**DO NOT PHYSICALLY CONNECT EQUIPMENT TO THE POWER SOURCE UNTIL "POWER UP" PROCEDURES HAVE BEEN COMPLETED.**

Read the section on POWERING UP (page 19) before connecting the system to the power source, and check the various System Configurations shown in the Appendix.

**Connections**

All system connections are made on the rear panels of the system bays. Connections for several typical System Configurations are described in pages 20 through 47. See the Appendix for illustrations of various system connections.

**Note: Make all internal jumper switch settings on the modules before system connections are started (see SETUP, pages 12 - 18). Be certain that all connections are properly completed before applying power.**

All video connections should be made using a good grade, 75-ohm, RG-59U video cable (i.e., Belden 8241 or equivalent) with BNC connectors.

All video outputs must be terminated in 75 ohms at the last unit in the run. Set the intermediate units to HiZ. If the video run is not terminated, or if it is double terminated, the resulting picture will be of poor quality. If the run is not terminated a brighter picture than desired will be displayed. Conversely, if the run is double terminated, a darker picture than desired will be displayed.

Each installation should be made in a planned and orderly manner. The operation of each piece of equipment should be confirmed as early as possible during the installation procedure. It is much easier to remove a few temporary terminations, or connections, after a confirmation check than it is to disconnect and re-wire a large number of "permanent" connections.

To facilitate maintenance and assist in service, all connecting cables should be identified with source/destination numbers.

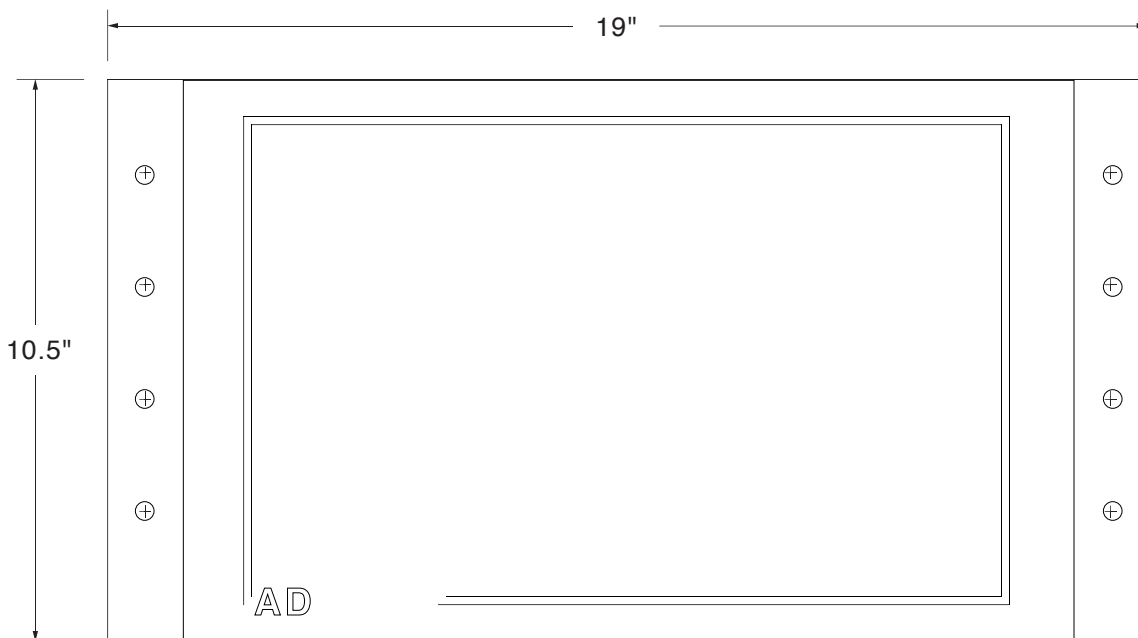

Figure 24 - Bay Mounting Dimensions

**SETUP**

**SETUP - Internal Jumper Switches**

**CAUTION** - Due to the presence of non-insulated components with hazardous voltages, the following internal adjustments should be performed by qualified service personnel only.

**Data Buffer Module Switches**

The 2010DB Data Buffer Module serves a dual purpose. First, it sends video to the monitors and second, it filters incoming information from the high speed LAN line.

Filtering is accomplished with two 8-position DIP switches, S2 and S3. Switch position 1 of switch S2 turns the filter "ON" or "OFF." If S2 is set to "ON", all information passes and S3 does not have to be set. If S2 is set to "OFF", only specified information passes and S3 must be set. The S3 switch allows only the necessary information to pass for that particular bay.

In the Condensed Bay configuration, or when a bay contains 2024VOM monitor modules, the filter is set such that all information passes. Therefore, position 1 of switch S2 is set to ON.

For all other configurations the filter is set such that information is filtered, thus position 1 of switch S2 is set to OFF and S3 must be set accordingly. This applies to bays which contain only 2016 VIM camera modules.

The Data Buffer Module also has a 2-position slide switch, S1. S1 switches the card into either a normal mode or test mode. S1 should be kept at the normal position.

Figure 25 shows the location of these switches on the 2010DB PCB card.

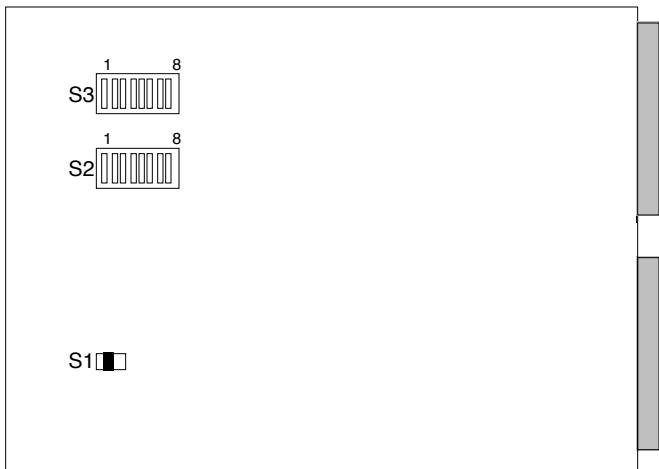

Figure 25 - Data Buffer Card Switches

**Table 1 - S2 and S3 switch settings**

1=On; 0=Off; X=Don't care

**Switch S2**

<b>Filter</b>	<b>1</b>	<b>2</b>	<b>3</b>	<b>4</b>	<b>5</b>	<b>6</b>	<b>7</b>	<b>8</b>
Pass all information (S2 ON)	1	0	X	X	X	X	X	X
Pass only specified information (S2 OFF)	0	0	X	X	X	X	X	X

**Note:** S2 must be set to pass all information (ON) in bays which contain 2024VOM monitor modules.

**Switch S3**

<b>Camera</b>	<b>Monitor</b>	<b>1</b>	<b>2</b>	<b>3</b>	<b>4</b>	<b>5</b>	<b>6</b>	<b>7</b>	<b>8</b>
1-256	1-16	X	X	0	0	X	0	0	X
257-512	1-16	X	X	1	0	X	0	0	X
513-768	1-16	X	X	0	1	X	0	0	X
769-1024	1-16	X	X	1	1	X	0	0	X
1-256	17-32	X	X	0	0	X	1	0	X
257-512	17-32	X	X	1	0	X	1	0	X
513-768	17-32	X	X	0	1	X	1	0	X
769-1024	17-32	X	X	1	1	X	1	0	X
1-256	33-48	X	X	0	0	X	0	1	X
257-512	33-48	X	X	1	0	X	0	1	X
513-768	33-48	X	X	0	1	X	0	1	X
769-1024	33-48	X	X	1	1	X	0	1	X
1-256	49-64	X	X	0	0	X	1	1	X
257-512	49-64	X	X	1	0	X	1	1	X
513-768	49-64	X	X	0	1	X	1	1	X
769-1024	49-64	X	X	1	1	X	1	1	X

**Video Loss Detector Data Buffer Module Switches**

The 2010DBVL (Video Loss Detector Data Buffer Module) is similar to the 2010DB, with the added capability of video loss detection for each camera of the bay. A video loss detection message is transmitted via the RJ45 port on the 2010DBVL rear panel. An Alarm Contact is also provided from this port (see connector pinouts, page 7).

The 2010DBVL is configured with a 2-position slide switch, S1, and three 8-position DIP switches: S2, S3, and S4. S1 is set for normal/test mode, as described for the 2010DB module.

DIP switch S2 sets the filtering mode, as described for the 2010DB, the Alarm Contact mode, and the RJ45 port baud rate. Switch position 2 of S2 must be set to ON for the module to function as a Video Loss Detection module.

The Alarm Contact modes are:

Alarm during Video or Sync Loss - The Alarm Contact is closed and the ALARM LED on the 2010DBVL front panel is illuminated when a sync or video loss is first detected; both remain on until the loss is cleared.

Alarm during loss, plus 10 seconds - The Alarm Contact is closed and the ALARM LED is illuminated as above, but both remain on for 10 seconds after the loss is cleared.

Alarm at loss for 10 seconds - The Alarm Contact is closed and the ALARM LED is illuminated as above, but both remain on for only 10 seconds.

Alarm at loss for 20 seconds - The Alarm Contact is closed and the ALARM LED is illuminated as above, but both remain on for only 20 seconds.

The baud rate setting of DIP switch S2 configures the RJ45 port on the 2010DBVL for the desired communications rate.

DIP switch S3 must be set to the camera and monitor group numbers assigned to the switching bay modules.

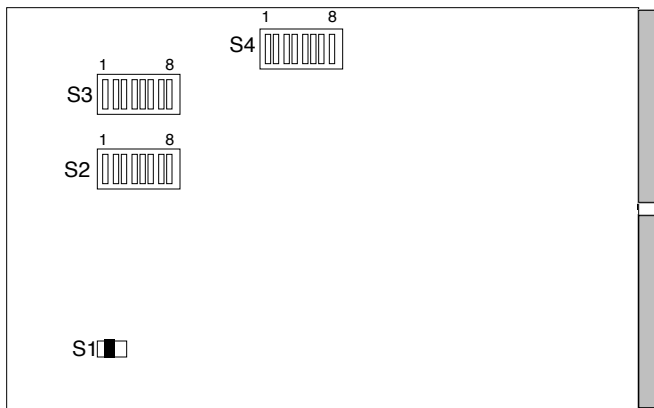

Figure 26 - DBVL Data Buffer Card Switches

DIP switch S4 sets the type of communication used via the RJ45 port and enables or disables the 2010DBVL front panel LED's. This port may be configured for RS-232, RS-422, or RS-485 communications.

The following tables show the switch position settings for DIP switches S2, S3, and S4. Figure 26 shows the location of these DIP switches on the 2010DBVL PCB card.

**Table 2 - S2, S3, and S4 switch settings**

1=On; 0=Off; X=Don't care

**DIP Switch S2**

<u>Function</u>	<u>2</u>	<u>3</u>	<u>6</u>
Video Loss Enabled	1	X	X
Video Loss Disabled	0	X	X
	<u>1</u>		
Pass all information	1		
Pass only specified information	0		
		<u>4</u>	<u>5</u>
Alarm during Video or Sync loss		0	0
Alarm during loss, plus 10 seconds		1	0
Alarm at loss for 10 seconds		0	1
Alarm at loss for 20 seconds		1	1
			<u>7</u>
1200 Baud Rate			0
2400 Baud Rate			0
4800 Baud Rate			1
9600 Baud Rate			0
			1

**DIP Switch S3**

<u>Camera</u>	<u>Monitor</u>	<u>1</u>	<u>2</u>	<u>3</u>	<u>4</u>	<u>5</u>	<u>6</u>	<u>7</u>	<u>8</u>
1-256	1-16	X	X	0	0	X	0	0	X
257-512	1-16	X	X	1	0	X	0	0	X
513-768	1-16	X	X	0	1	X	0	0	X
769-1024	1-16	X	X	1	1	X	0	0	X
1-256	17-32	X	X	0	0	X	1	0	X
257-512	17-32	X	X	1	0	X	1	0	X
513-768	17-32	X	X	0	1	X	1	0	X
769-1024	17-32	X	X	1	1	X	1	0	X
1-256	33-48	X	X	0	0	X	0	1	X
257-512	33-48	X	X	1	0	X	0	1	X
513-768	33-48	X	X	0	1	X	0	1	X
769-1024	33-48	X	X	1	1	X	0	1	X
1-256	49-64	X	X	0	0	X	1	1	X
257-512	49-64	X	X	1	0	X	1	1	X
513-768	49-64	X	X	0	1	X	1	1	X
769-1024	49-64	X	X	1	1	X	1	1	X

**DIP Switch S4**

<u>Function</u>	<u>1</u>	<u>2</u>	<u>3</u>	<u>4</u>	<u>5</u>	<u>6</u>	<u>7</u>	<u>8</u>
RS-232	1	1	0	0	0	0	0	0
RS-422	0	0	1	1	0	0	0	0
RS-485	0	0	1	1	1	1	0	0
								<u>8</u>
Front Panel LED's ON								1
Front Panel LED's OFF								0

# SETUP

## Video Input Module Switches

The 2016AVIM (Video Input Module) performs the actual video switch. Each module can switch any one of 16 video inputs to any video output, or multiple combinations of video outputs, up to 16.

The 2016A Video Input Module must be set to the cameras and monitors it is to respond to. There are two 8-position dip switches. DIP switch S1 is used to set all field configurations.

The eight position dip switch S1, located on the circuit board, must be set to identify the camera and monitor group. The first two switches select one of four groups of 16 monitors and the last six select one of 64 groups of 16 cameras. Switch settings are shown in Table 3.

The monitor group selection is independent of the camera group selection. Yet both monitor and camera group must be selected correctly depending on the particular slot the card is being placed in. **Note:** The silkscreen on the board clearly shows the correct dip switch to use. The word "CAM GRP" is screened adjacent to the correct dip switch.

The DIP switch S3 is not used in this module.

**Table 3 - S1 Camera and Monitor Identification**

1=On; 0=Off; X=Don't care

<u>Monitors</u>	<u>Switch Positions</u>							
	<u>1</u>	<u>2</u>	<u>3</u>	<u>4</u>	<u>5</u>	<u>6</u>	<u>7</u>	<u>8</u>
1- 16	0	0	X	X	X	X	X	X
17- 32	0	1	X	X	X	X	X	X
33- 48	1	0	X	X	X	X	X	X
49 - 64	1	1	X	X	X	X	X	X
65- 80	0	0	X	X	X	X	X	X
81- 96	0	1	X	X	X	X	X	X
97 - 112	1	0	X	X	X	X	X	X
113 - 128	1	1	X	X	X	X	X	X

### Camera

1-16	X	X	0	0	0	0	0	0
17-32	X	X	0	0	0	0	0	1
33-48	X	X	0	0	0	0	1	0
49-64	X	X	0	0	0	0	1	1
65-80	X	X	0	0	0	1	0	0
81-96	X	X	0	0	0	1	0	1
97-112	X	X	0	0	0	1	1	0
113-128	X	X	0	0	0	1	1	1
129-144	X	X	0	0	1	0	0	0
145-160	X	X	0	0	1	0	0	1
161-176	X	X	0	0	1	0	1	0
177-192	X	X	0	0	1	0	1	1

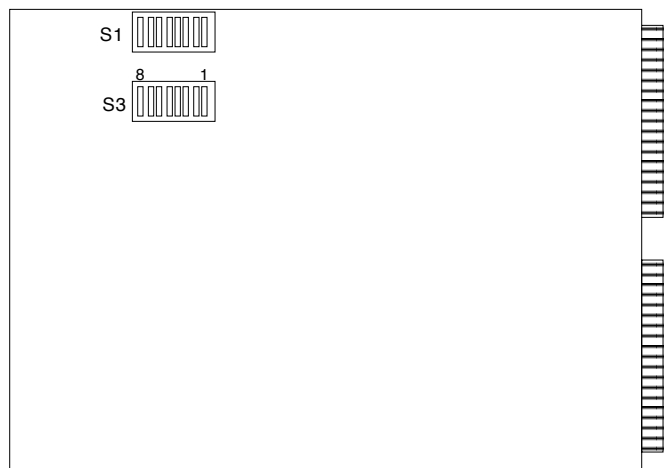

Figure 27 - Video Input Module Card Jumper Switches

**Table 3 - S1 Camera and Monitor Identification**  
(continued)

<b>Camera</b>	<b>Switch Positions</b>							
	<b>1</b>	<b>2</b>	<b>3</b>	<b>4</b>	<b>5</b>	<b>6</b>	<b>7</b>	<b>8</b>
193-208	X	X	0	0	1	1	0	0
209-224	X	X	0	0	1	1	0	1
225-240	X	X	0	0	1	1	1	0
241-256	X	X	0	0	1	1	1	1
257-272	X	X	0	1	0	0	0	0
273-288	X	X	0	1	0	0	0	1
289-304	X	X	0	1	0	0	1	0
305-320	X	X	0	1	0	0	1	1
321-336	X	X	0	1	0	1	0	0
337-352	X	X	0	1	0	1	0	1
353-368	X	X	0	1	0	1	1	0
369-384	X	X	0	1	0	1	1	1
385-400	X	X	0	1	1	0	0	0
401-416	X	X	0	1	1	0	0	1
417-432	X	X	0	1	1	0	1	0
433-448	X	X	0	1	1	0	1	1
449-464	X	X	0	1	1	1	0	0
465-480	X	X	0	1	1	1	0	1
481-496	X	X	0	1	1	1	1	0
497-512	X	X	0	1	1	1	1	1
513-528	X	X	1	0	0	0	0	0
529-544	X	X	1	0	0	0	0	1
545-560	X	X	1	0	0	0	1	0
561-576	X	X	1	0	0	0	1	1
577-592	X	X	1	0	0	1	0	0
593-608	X	X	1	0	0	1	0	1
609-624	X	X	1	0	0	1	1	0
625-640	X	X	1	0	0	1	1	1
641-656	X	X	1	0	1	0	0	0
657-672	X	X	1	0	1	0	0	1
673-688	X	X	1	0	1	0	1	0
689-704	X	X	1	0	1	0	1	1
705-720	X	X	1	0	1	1	0	0
721-736	X	X	1	0	1	1	0	1
737-752	X	X	1	0	1	1	1	0
753-768	X	X	1	0	1	1	1	1
769-784	X	X	1	1	0	0	0	0
785-800	X	X	1	1	0	0	0	1
801-816	X	X	1	1	0	0	1	0
817-832	X	X	1	1	0	0	1	1
833-848	X	X	1	1	0	1	0	0
849-864	X	X	1	1	0	1	0	1
865-880	X	X	1	1	0	1	1	0
881-896	X	X	1	1	0	1	1	1
897-912	X	X	1	1	1	0	0	0
913-928	X	X	1	1	1	0	0	1
929-944	X	X	1	1	1	0	1	0
945-960	X	X	1	1	1	0	1	1
961-976	X	X	1	1	1	1	0	0
977-992	X	X	1	1	1	1	0	1
993-1008	X	X	1	1	1	1	1	0
1009-1024	X	X	1	1	1	1	1	1

# SETUP

## Video Output Module Switches

The 2024VOM (Video Output Module) adds character information in the form of titles and time and date to switched video from 2016AVIM modules. Each 2024VOM card contains 2-pin jumpers and one 8-position DIP switch (see Figure 28). These are set with the module removed from the bay.

Four 2-pin jumpers for setting monitor identification are set at the back of the card (end with gold-plated connections). Each card can be set for monitors:

- one, two, three, and four; or
- five, six, seven, and eight; or
- nine, ten, eleven, and twelve; or
- thirteen, fourteen, fifteen, and sixteen.

There is no other variations, only the four types described above.

**Note:** The silkscreen labeling on the VOM board shows which jumper is for which monitor; these are labeled M1 through M16. When setting monitors over sixteen, subtract multiples of sixteen from the monitor number you want to set. For example, to set monitors 33-36, subtract 32 to obtain monitors one through four (33-32=1; 35-32=3, etc).

For selection of video type (Phase Adjusted Line, PAL or National Television Systems Committee, NTSC), locate the 2-position jumper terminal near the center edge of the card. Position the plastic 2-pin jumper to the appropriate location.

For selection of bay configuration (Standard or Condensed), locate the 2-position jumper terminal near the center of the two gold connectors. All bays are configured with the jumper position set to "standard bay". In Condensed Bays, the jumper is set to "standard bay" for cards corresponding to monitors 17 to 32, while the jumper is set to "condensed (or split) bay" for cards corresponding to monitors 1 to 16.

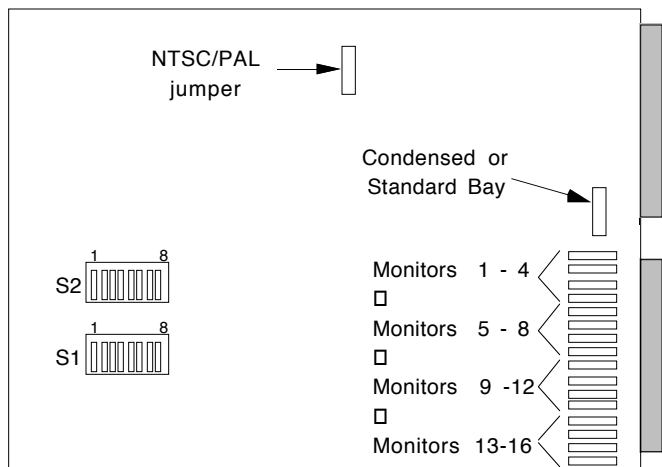

Figure 28 - VOM Card Jumper Switches

**Note:** The bay configuration switch was implemented on Rev "B" boards. Before Rev "B" boards, resistors were placed on the solder side of the board (Condensed Bays only).

The 8-position DIP switch S2, located on the circuit board, must be set to identify the video inputs and outputs the module must respond to. Switch settings are dependent on the slot location in the matrix bay as well as which matrix bay the card is located. Switch settings are shown in Tables 4a, 4b, and 5.

Table 4 represents the first four switches of S2, which identifies video input. If the video output is located in a matrix switching bay that includes video input cards its video input would be considered internal. If the video output card is located in a matrix switching bay which contained only output cards its video inputs would be considered external.

Table 5, on page 17, identifies which video outputs the card will be controlling.

**Table 4a - S2 Internal Video Input Identification**

	1=On	0=Off	Switch Positions	
<u>Video Inputs</u>	<u>1</u>	<u>2</u>	<u>3</u>	<u>4</u>
1 to 256	0	0	0	0
257 to 512	1	0	0	0
513 to 768	0	1	0	0
769 to 1024	0	0	1	0

**Table 4b - S2 External Video Input Identification**

	1=On	0=Off	Switch Positions	
<u>Video Inputs</u>	<u>1</u>	<u>2</u>	<u>3</u>	<u>4</u>
1 to 256	1	0	0	0
257 to 512	0	1	0	0
513 to 768	0	0	1	0
769 to 1024	0	0	0	1

**Note:** Table 4a is used when the 2024VOM is located in a matrix switching bay which includes 2016AVIM. Table 4b is used when the 2024VOM is located in a matrix switching bay which does not include 2016AVIM modules. In both instances, the Filter DIP switch S2 on the 2010DB/2010DBVL Data Buffer Module must be set to pass all data (see page 12).

DIP Switch S1 and slide Switch S3 are not used on the 2024VOM card.

**Table 5 - S2 Video Output Identification**

1=On 0=Off

Video Output	Switch Positions			
	<u>5</u>	<u>6</u>	<u>7</u>	<u>8</u>
1 to 4	0	0	0	0
5 to 8	1	0	0	0
9 to 12	0	1	0	0
13 to 16	1	1	0	0
17 to 20	0	0	1	0
21 to 24	1	0	1	0
25 to 28	0	1	1	0
29 to 32	1	1	1	0
33 to 36	0	0	0	1
37 to 40	1	0	0	1
41 to 44	0	1	0	1
45 to 48	1	1	0	1
49 to 52	0	0	1	1
53 to 56	1	0	1	1
57 to 60	0	1	1	1
61 to 64	1	1	1	1

**Video Output Module - Horizontal, Vertical, and Brightness Adjustment**

The 2024VOM has four video outputs each with title information displayed on the video picture. The title information on the screen is adjustable for horizontal and vertical position. The brightness of the characters is also adjustable. The rotary switch located on the front panel of each output module selects which output will be adjusted. The "H", "V" and "B" pushbuttons are used to adjust the desired setting. See Figure 29 for location of these controls.

The video output title to be controlled is selected from the rotary switch labeled "A . . D". To select the first video output, turn the rotary switch to position "A". To select the second video output for title adjustment, move the rotary switch clockwise one position. Proceed in this manner for the final two video outputs.

After selecting one of the four outputs, press the "H" pushbutton. The title shifts to the right until the pushbutton is released.

**Note:** If the pushbutton is not released, the title will reach an end point and return to the left-most position and begin to shift to the right again.

After the proper horizontal position has been selected, depress the "V" pushbutton. The title will shift downward until the pushbutton is released. **Note:** If the pushbutton is not released, the title will reach the bottom of the screen, as defined by the vertical sync, move to the top of the screen, and begin to shift down again.

After the proper horizontal and vertical positions have been selected, proceed to the brightness control. The characters of the title are white with a black border. This enhances visibility under varying light conditions. The brightness control provides eight steps of white levels to change the characters from white to black. To change the brightness of the titles, depress the "B" pushbutton. The title steps through each level until the pushbutton is released.

The video output rotary switch may be placed to any position when title adjustment is completed.

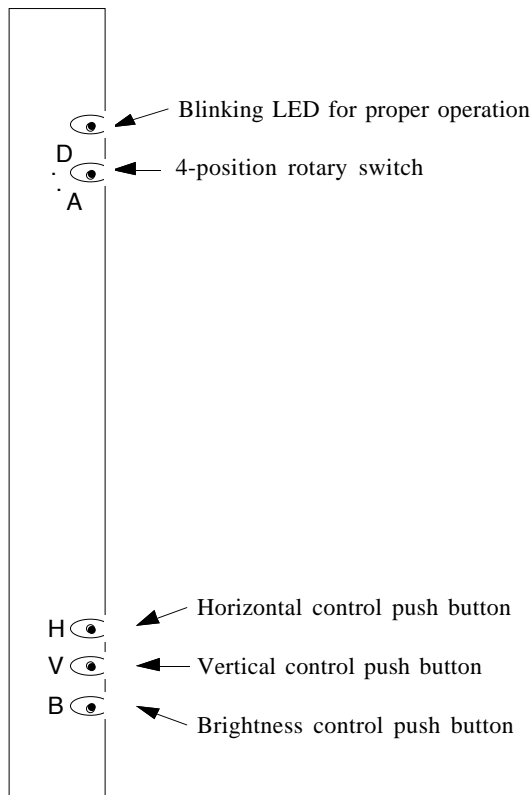

Figure 29 - Video Output Module Front Panel

## SETUP

### Power Supply Set Up - Vertical Phase Adjustment

The matrix switching bays are designed as vertical interval switches, thus giving the matrix switching bay the ability to switch between properly phased video inputs without producing a vertical roll, or a black bar, between each video switch. Use of this feature allows vertical interval switching to be controlled by the AC Line (Line Locked), External Vertical Drive (Generator Locked), or Composite video input.

1. **AC LINE:** The most common form of synchronization is AC line lock of the vertical switching point. To use this feature, switch the Sync Reference Selection switch to AC LINE (see Figure 1 on page 2). This will use the AC (either 60 or 50 Hz) line to determine the vertical timing. If all video inputs use the same phase of AC power to determine the vertical timing, no roll will appear.

As an aid to the installer, a switch on the Power Supply Module is available to check the vertical switch location for each video input. This function is initiated when the SET UP/NORMAL switch is selected to the SET UP position.

- A. Connect a monitor to the top most BNC of the 2010DB-00 labeled Test/Expansion Only, or the first monitor output of any level VOM. If the monitor card is present, connect to the video output module monitor 1. If not, use the Data Buffer output #1.
- B. From an external keyboard call input 1 to output 1.
- C. Place the SET UP/NORMAL switch to the SET UP position. This implements the phase adjustment procedure.  
**Note:** The Sync Test On/Off LED will be blinking when the sync test switch is in the SETUP position.

Notice that the alignment bar, displayed on output 1, shows the location of the vertical switch with respect to the picture.

- D. The phase adjustment potentiometer, accessed thru the hole in the front panel of the Power Supply, adjusts the phase of the vertical interval synchronization pulse for the switcher with respect to the selected reference.
- E. Adjust the position of the bar with a TV alignment tool, or equivalent, by turning the phase potentiometer, until the line is located as seen in Figure 30. The line should be visible on the screen.

**Once the alignment bar is set, no further adjustment to the potentiometer is necessary.**

- F. Select the second video input in the system. If the horizontal bar is not in the same location as seen in Figure 30, adjust the sync location on the "video device" (i.e., video camera) until the horizontal bar is located towards the bottom of the screen. If this is not possible, and the alignment bar is located in a different position than it was

in the previous camera, you will experience camera roll during switching operations to that camera.

- G. Repeat this for all video inputs to the system.  
**Note:** Before adjusting all of the video inputs, quickly scan all inputs to see if only a few are out of phase and adjust accordingly (input one may be the only oddball!).
- H. Once all cameras have been synchronized, place the SET UP/NORMAL switch to the NORMAL position.

If multiple matrix switching bays are used, repeat steps A - H for each bay. The sync/test output for these bays is the top most output BNC located on each 2010DB-XX rear panel at the first monitor of the bay, i.e., monitor 17-32, etc.

2. **EXT V-DRIVE:** If an external generator is used to control the vertical switching point, switch the Sync Reference Selection switch to EXT V-DRIVE (external vertical drive). For proper operation, the output voltage of the generator should not exceed 5V peak-to-peak (p-p). Connect the drive output from the generator to the EXT SYNC IN BNC located on the 2010PS rear panel. Connect a 75-ohm terminator to the EXT SYNC OUT BNC. If other bays are used, loop the EXT SYNC from input to output for all bays and terminate the last bay EXT SYNC OUT BNC in 75-ohms.

3. **EXT CAM:** If composite video is used to control the vertical switching point, switch the Sync Reference Selection switch to EXT CAM (external camera). For proper operation, the composite sync signal is specified at 1.1V p-p. Connect the composite sync to the EXT SYNC IN BNC located on the 2010PS rear panel. Connect a 75-ohm terminator to the EXT SYNC OUT BNC. If other bays are used, loop the EXT SYNC from input to output for all bays and terminate the last bay EXT SYNC OUT BNC in 75-ohms.

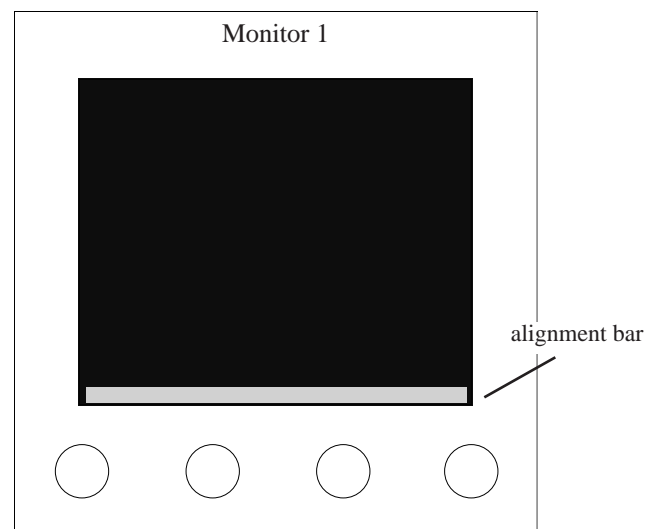

Figure 30 - Placement of Setup Alignment Bar  
Alignment bar should be visible on the monitor and not in the vertical sync.



---

## POWERING UP

The system may be brought on line after:

- The CPU has been installed and connected.
- A video input has been connected.
- A monitor has been connected for viewing the output.
- All lines have been properly terminated.
- One keyboard (or external computer) has been connected for control.
- Power has been connected to the equipment, one bay at a time, ending with the CPU.

### Powering the Matrix Bay

1. Unscrew the two thumbscrews located at the top corners of front panel of each matrix switching bay.
2. Remove the front panel by first slowly pulling the top of the panel towards the front, then lifting the panel up.

**Note:** DO NOT remove the foam material attached to the front panel.

3. Verify that the unit is turned off. The unit is turned off by pressing the bottom of the front panel power On/Off switch.
4. Power is supplied via a pendant cord and plug. Connect the pendant cord to the required voltage input:

AD1024R	120VAC, 50/60 Hz
ADS1024RX	230VAC, 50/60 Hz
5. To turn the unit on, press the top of the front panel power On/Off switch.

Replace the front panel only after all setup adjustments have been made related to powering up instructions (Power Supply Module and Video Output Module, prior pages).

6. To replace the front panel, slip the bottom of the panel into the slot at the bottom of the bay. Push the top of the panel towards the bay and tighten the two corner thumb screws.

## SYSTEM CONFIGURATIONS

### SYSTEM CONFIGURATIONS

The following sections of this manual are organized specific to the system level to be installed. A level is defined as 16 video outputs, and may consist of one to several bays. Level 1 is for a maximum of 16 outputs, Level 2 is for 32 outputs, and so on up to Level 8 which is for a maximum of 128 outputs.

System bays are supplied in the following two configurations: Standard (Model 2010R) and Condensed (Model 2020R).

**References to "Right" or "Left" in the following instructions apply to the Bays as viewed from the REAR.**

### LEVEL 1 SYSTEMS

Level 1 systems can have a maximum of five 2010R Standard matrix switching bays that each contain the 2010PS Power Supply Module and a 2010DB or 2010DBVL Data Buffer Module. Level 1 Systems can consist of a maximum of AD1024 video inputs and a maximum of 16 video outputs (15 outputs if the 2010DBVL module is used).

For a Level 1 system with Video Loss Detection capability, the video output for monitor 16 is replaced by the Video Loss Detection function in the 2010DBVL Module. Since each 2010DBVL can detect video losses for a maximum of 256 cameras, an additional 2010DBVL Module is required in each camera bay, for each block of 256 cameras. The first camera bay would use a 2010DBVL-11, the second bay a 2010DBVL-21, the third bay a 2010DBVL-31 and the fourth bay a 2010DBVL-41. In a multi-bay system where the last bay contains both camera modules and monitor modules, that bay would use a 2010DBVL-00 module. In a five-bay system, the fifth bay is exclusively a monitor bay and would require the 2010DB-00 Module, not the 2010DBVL-00.

### LEVEL 1 - 256 X 16, One Bay System with no Titles

A one bay, Level 1 system, without VOM modules for video titles, allows a maximum of 256 video inputs switched to a maximum of 16 video outputs.

**This system does not contain 2024VOM modules.**

From the rear of the bay, the modules are installed at the factory in the following manner; the far right module is the 2010PS; the next module is the 2010DB-01 with 16 BNCs for untitled video outputs, followed by one to sixteen 2016AVIM-1 modules. Smaller matrices, such as those ordered with future expansion in mind, may have fewer modules installed.

### IDENTIFY THESE MODULES CAREFULLY BEFORE PROCEEDING.

**Data Interconnect:** Connect a 75-ohm coaxial cable from the DATA LINE-1 output on the AD1024 CPU, to the Data IN BNC on the 2010PS rear panel. Connect a 75-ohm BNC terminator (supplied with the CPU) to the Data Out BNC on Power Supply rear panel.

**Video Input Connections:** The 2016AVIM is identified with the camera input icon .

The starting camera number, for the particular VIM, is located at the top BNC. Each 2016AVIM-1 includes 16 terminated BNCs for video input connections. The first 2016AVIM-1, located immediately to the left of the 2010DB-01, is for video inputs 1 - 16, the second 2016AVIM-1 module is for inputs 17 - 32, etc.

In succession, connect the video inputs to each 2016AVIM-1 module, top to bottom. Each VIM will accept 16 video inputs. Continue until all inputs are connected to the system. Unused video inputs, on the VIM, do not require any external connection or termination, and may be left open. See Figure 16, Video Input Module, page 8.

**Video Output Connections with No Titles:** Each 2010DB-01 in the system has 16 BNCs. The top most BNC corresponds to video output 1 and the bottom video output corresponds to number 16. Connect the video outputs to any device that accepts standard video such as monitors or video recorders. See Figure 4, 2010DB-01 Rear Panel with 16 BNCs, page 4.

In the Appendix, see Figure A1, 256 X 16, One Bay System with No Titles.

**LEVEL 1 - 256 X 15, One Bay System with Video Loss Detection**

A one bay, Level 1 system, with video loss detection and without video titles, allows a maximum of 256 video inputs switched to a maximum of 15 video outputs.

This system is the same configuration of modules as the LEVEL 1 - 256 X 16 system except that the 2010DBVL-01 Video Loss Detection Data Buffer module is installed in place of the 2010DB-01 module. The connections are as described for that system configuration, except that only 15 BNCs are provided for video outputs.

See Appendix Figure A18, 256 X 15, One Bay System with Video Loss Detection Module.

**LEVEL 1 - 192 X 16, One Bay System**

A one bay, Level 1 system, with 2024VOM modules for video titles, allows a maximum of 192 video inputs switched to a maximum of 16 video outputs.

From the rear of the bay, the modules are installed at the factory in the following manner; the far right module is the 2010PS; the next module is the 2010DB-00, followed by twelve 2016AVIM-1 modules, and four 2024VOM-1 modules. Smaller matrices, such as those ordered with future expansion in mind, may have fewer modules installed.

**IDENTIFY THESE MODULES CAREFULLY BEFORE PROCEEDING.**

**Data Interconnect:** Connect a 75-ohm coaxial cable from the DATALINE-1 output on the AD1024 CPU to the DATA IN BNC on the 2010PS rear panel. Connect a 75-ohm BNC terminator (supplied with the CPU) to the Data Out BNC on the Power Supply rear panel.

**Video Input Connections:** The 2016AVIM is identified with the video input icon.



The starting video input number, for the particular VIM, is located at the top BNC. Each 2016AVIM-1 includes 16 terminated BNCs for video input connections. The first 2016AVIM-1, located immediately to the left of the 2010DB-00, is for video inputs 1-16, the second 2016AVIM-1 module is for inputs 17- 32, etc.

In succession, connect the video inputs to each 2016AVIM-1 module, top to bottom. Each VIM will accept 16 video inputs. Continue until all inputs are connected to the system. Unused video inputs, on the VIM, do not require any external connection or termination, and may be left open. See Figure 16, Video Input Module, page 8.

**Video Output Connections:** Each 2024VOM-1 has a rear panel with 16 BNCs. For single bay systems, only the bottom four BNCs are used for video output connections. The left most module is assigned to outputs 1 - 4. Moving left to right, the next VOM module is assigned to outputs 5 - 8, etc. (The modules are numbered 1 - 4, 5 - 8, etc.) Connect the video outputs to any device that accepts standard video such as monitors or video recorders. See Figure 21, Video Output Module, page 9.

In the Appendix, see Figure A2, 192 X 16, One Bay System.

**LEVEL 1 - 448 X 16, Two Bay System**

A two bay, Level 1 system allows a maximum of 448 video inputs switched to a maximum 16 video outputs. Bay one consists of the first 256 video inputs. Bay two consists of the remaining 192 video inputs and four video output modules.

From the rear of bay one, the modules are installed at the factory in the following manner; the far right module is the 2010PS, the next module is the 2010DB-11 with 16 BNCs for connection to the 2024VOM-1 modules in bay two, followed by sixteen 2016AVIM-1 modules for inputs 1 - 256.

From the rear of bay two, the modules are installed at the factory in the following manner; the far right module is the 2010PS, the next module is the 2010DB-00, followed by twelve 2016AVIM-1 modules for inputs 257 - 448, and four 2024VOM-1 modules for outputs 1 - 16.

Smaller matrices, such as those ordered with future expansion in mind, may have fewer modules installed.

**IDENTIFY THESE MODULES CAREFULLY BEFORE PROCEEDING.**

**Data Interconnect:** Connect a 75-ohm coaxial cable from the DATALINE-1 output on the AD1024 CPU to the DATA IN BNC of Bay 1. Connect a 75-ohm coaxial cable from the DATA OUT BNC of bay 1 to the DATA IN BNC 2010PS rear panel of bay 2. Connect a 75 ohm BNC terminator (supplied with the CPU) to the Data Out BNC of Bay 2.

**Video Interconnections:** The 16 video outputs from bay 1, located on the rear panel of the 2010DB-11, are grouped by fours and identified by the icon . Each 2024VOM-1 is similarly grouped with three sections of four BNCs, with identifying icons. See Figure 5, Data Buffer, page 4.

Using high grade RG-59U video cables, connect the topmost BNC from bay 1 on the 2010DB-11 panel, numbered 1, to the topmost input BNC, labeled 1 on the 2024VOM-1 in bay 2, for output 1, matching icon to icon . See Appendix Figure A18, Video Interconnections, for illustration of these connections.

Continue in this manner until 1-4 of the 2010DB-11 panel are connected to inputs 1-4 of the first 2024VOM-1. Proceed to the next group of four BNCs on the 2010DB-11 panel. Connect these four to the second 2024VOM-1 for outputs 5-8. Continue in this manner until all 16 connections of the 2010DB-11 panel are connected to all of the 2024VOM-1 modules. If there are less than four 2024VOM modules in the system, leave the remaining BNCs on 2010DB-11 of bay 1 open.

**Video Input Connections:** The 2016AVIM is identified with the camera input icon.



The starting camera number for the particular VIM is located at the top BNC. Each 2016AVIM-1 includes 16 terminated BNCs for video input connections. The first 2016AVIM module is for video inputs 1 - 16, the second VIM module is for inputs 17 - 32, etc.

In succession, connect the video inputs to each 2016AVIM-1 module, top to bottom. Each VIM will accept 16 video inputs. Continue until all inputs are connected to the system. Unused video inputs, on the VIM, do not require any external connection or termination, and may be left open. See Figure 16, Video Input Modules, page 8.

**Video Output Connections:** Each 2024VOM-1 has a rear panel with 16 BNCs, only the bottom four BNCs are used for video output connections. The left most module is assigned to outputs 1 - 4. Moving left to right, the next VOM module is assigned to outputs 5 - 8, etc. (The modules are numbered 1 - 4, 5 - 8, etc.) Connect the video outputs to any device that accepts standard video such as monitors or video recorders. See Figure 21, Video Output Module, page 9.

In the Appendix, see Figure A3, 448 X 16, Two Bay System.

**LEVEL 1 - 448 X 16, Two Bay System with Video Loss Detection**

A two bay, Level 1 system, with video loss detection, allows a maximum of 448 video inputs switched to a maximum of 15 video outputs.

This system is the same configuration of modules as the LEVEL 1 - 448 X 16 system above, except that the 2010DBVL-11 module is installed in place of the 2010DB-11 module in bay one and the 2010DBVL-00 module is installed in place of the 2010DB-00 module in bay two. The connections are as described for the above system configuration, except that only 15 BNCs are provided for video outputs.

Since two 2010DBVL modules are used, this configuration requires the use of the 1981 Port Expander for connection to the ADAD1024 CPU.

See Appendix Figure A21, 256 X 15, Two Bay System with Video Loss Detection Module.

**LEVEL 1 - 704 X 16, Three Bay System**

A three bay, Level 1 system allows a maximum of 704 video inputs switched to a maximum 16 video outputs. Bays one and two consist of 256 video inputs and bay three consists of 192 video inputs and 16 video outputs.

From the rear of bay one, the modules are installed at the factory in the following manner; the far right module is the 2010PS, the next module is the 2010DB-11 with 16 BNCs for connection to the 2024VOM-1 modules in bay three, followed by sixteen 2016AVIM-1 modules for inputs 1 - 256.



From the rear of bay two, the modules are installed at the factory in the following manner; the far right module is the 2010PS, the next module is the 2010DB-21 with 16 BNCs for connection to the 2024VOM-1 modules in bay three, followed by sixteen 2016AVIM-1 modules for inputs 257 - 512.

From the rear of bay three, the modules are installed at the factory in the following manner; the far right module is the 2010PS, the next module is the 2010DB-00, followed by twelve 2016AVIM-1 modules for inputs 513 - 704 and four 2024VOM-1 modules for outputs 1-16.

Smaller matrices, such as those ordered with future expansion in mind, may have fewer modules installed.

**IDENTIFY THESE MODULES CAREFULLY BEFORE PROCEEDING.**

**Data Interconnect:** See Level 1 - 448 X 16, Two Bay System and connect all bays in a similar manner.

**Video Interconnections:** The 16 video outputs from bay 1 and bay 2, located on the rear panel of the 2010DB-11 , and 2010DB-21 , are grouped by fours.

Each 2024VOM-1 is similarly grouped with three sections of four BNCs, with identifying icons. A fourth section of four BNCs is used for video output connections. See Figure 21, Video Output Module, page 9.

Using high grade RG-59U video cables, connect the topmost BNC from bay 1 on the 2010DB-11 panel, numbered 1, to the top-most input BNC, labeled 1 on the 2024VOM-1 in bay 3, for output 1, matching icon to icon.  Continue in this manner until BNCs 1-4 of the 2010DB-11 panel are connected to inputs 1-4 of the first 2024VOM-1. Proceed to the next group of four BNCs on the 2010DB-11 of the first bay. Connect these four to the second 2024VOM -1 for outputs 5 - 8. Continue in this manner until all 16 connections of the 2010DB-11 panel are connected to all of the 2024VOM-1 modules.

Connect bay 2 in a similar manner to the 2024VOM-1 modules of bay 3 for video outputs 1-16, matching icon to icon. 

See Appendix Figure A18, Video Interconnections, for illustration of these connections.

If there are less than four 2024VOM-1s in the system, the remaining BNCs on the 2010DB-XX do not require any connection.

**Video Input Connections:** See Level 1 - 448 X 16, Two Bay System and connect in a similar manner.

**Video Output Connections:** See Level 1 - 448 X 16, Two Bay System and connect in a similar manner.

In the Appendix, see Figure A4, 704 X 16, Three Bay System.

## SYSTEM CONFIGURATIONS

---

### LEVEL 1 - 960 X 16, Four Bay System

A four bay, Level 1 system allows a maximum of 960 video inputs switched to a maximum 16 video outputs. Bays one, two, and three each consist of 256 video inputs. Bay four consists of 192 video inputs and 16 video outputs.

From the rear of bay one, the modules are installed at the factory in the following manner; the far right module is the 2010PS, the next module is the 2010DB-11 with 16 BNCs for connection to the 2024VOM-1 modules in bay four, followed by sixteen 2016AVIM-1 modules, inputs 1 - 256.

From the rear of bay two, the modules are installed at the factory in the following manner; the far right module is the 2010PS, the next module is the 2010DB-21 with 16 BNCs for connection to the 2024VOM-1 modules in bay four, followed by sixteen 2016AVIM-1 modules, inputs 257 - 512.



From the rear of bay three, the modules are installed at the factory in the following manner; the far right module is the 2010PS, the next module is the 2010DB-31, with 16 BNCs for connection to the 2024VOM-1 modules in bay four, followed by sixteen 2016AVIM-1 modules, inputs 513 - 768.

From the rear of bay four, the modules are installed at the factory in the following manner; the far right module is the 2010PS, the next module is the 2010DB-00, followed by twelve 2016AVIM-1 modules for inputs 769 - 960, and four 2024VOM-1 modules for outputs 1 - 16.

Smaller matrices, such as those ordered with future expansion in mind, may have fewer modules installed.

#### **IDENTIFY THESE MODULES CAREFULLY BEFORE PROCEEDING.**

**Data Interconnect:** See Level 1 - 448 X 16, Two Bay System and connect all bays in a similar manner.

**Video Interconnections:** The 16 video outputs from bays 1, 2, and 3, located on the rear panel of the 2010DB-11 , 2010DB-21 , and 2010DB-31 , are grouped by fours and identified by the icons.

Each 2024VOM-1 is similarly grouped with three sections of four BNCs, with identifying icons. A fourth section of four BNCs is used for video output connections. See Figure 21, Video Output Module, page 9.

Using high grade RG-59U video cables, connect the topmost BNC from bay 1 on the 2010DB-11 panel, numbered 1, to the topmost input BNC, labeled 1 on the 2024VOM-1 of bay 4, for output 1, matching icon to icon. 

Continue in this manner until 1-4 of the 2010DB-11 panel are connected to inputs 1-4 of the first 2024VOM-1. Proceed to the next group of four BNCs on the 2010DB-11 of the first bay. Connect these four to the second 2024VOM-1 for outputs 5 - 8. Continue in this manner until all 16 connections of the 2010DB-11 panel are connected to all of the 2024VOM-1 modules.

Connect bay 2 in a similar manner to the 2024VOM-1 modules of bay 4 for video outputs 1-16, matching icon to icon. 

Connect bay 3 in a similar manner to the 2024VOM-1 modules of bay 4 for video outputs 1-16, matching icon to icon. 

See Appendix Figure A18, Video Interconnections, for illustration of these connections.

If there are less than four 2024VOM-1s in the system, the remaining BNCs on the 2010DB-XX do not require any connection.

**Video Input Connections:** See Level 1 - 448 X 16, Two Bay System and connect in a similar manner.

**Video Output Connections:** See Level 1 - 448 X 16, Two Bay System and connect in a similar manner.

In the Appendix, see Figure A5, Level 1 - 960 X 16, Four Bay System.

**LEVEL 1 - 1024 X 16, Five Bay System**

A five bay, Level 1 system allows a maximum of 1024 video inputs switched to a maximum 16 video outputs. Bays one through four each consists of 256 video inputs, and bay five consists of the 16 video outputs.

From the rear of bay one, the modules are installed at the factory in the following manner; the far right module is the 2010PS, the next module is the 2010DB-11 with 16 BNCs for connection to the 2024VOM-2 modules, followed by sixteen 2016AVIM-1 modules, inputs 1 - 256.

From the rear of bay two, the modules are installed at the factory in the following manner; the far right module is the 2010PS, the next module is the 2010DB-21 with 16 BNCs for connection to the 2024VOM-2 modules in bay five, followed by sixteen 2016AVIM-1 modules, inputs 257 - 512.

From the rear of bay three, the modules are installed at the factory in the following manner; the far right module is the 2010PS, the next module is the 2010DB-31 with 16 BNCs for connection to the 2024VOM-2 modules in bay five, followed by sixteen 2016AVIM-1 modules, inputs 513 - 768.





From the rear of bay four, the modules are installed at the factory in the following manner; the far right module is the 2010PS, the next module is the 2010DB-41 with 16 BNCs for connection to the 2024VOM-2 modules in bay five, followed by sixteen 2016AVIM-1 modules, inputs 769 - 1024.

From the rear of bay five, the modules are installed at the factory in the following manner; the far right module is the 2010PS, the next module is the 2010DB-00, followed by four 2024VOM-2 modules for outputs 1 - 16.

Smaller matrices such as those ordered with future expansion in mind, may have fewer modules installed.

**IDENTIFY THESE MODULES CAREFULLY BEFORE PROCEEDING.**

**Data Interconnect:** See LEVEL 1 - 448 X 16, two bay system and connect all bays in a similar manner.

**Video Interconnections:** The 16 video outputs from bay 1, through 4 are located on the rear panel of the 2010DB-11 , -21 , -31 , and -41  respectively.

They are grouped by fours and identified by their icons.

Each 2024VOM-2 is similarly grouped with four sections of four BNCs, with identifying icons. A fifth section of four BNCs, in the lower left corner, is used for video outputs. The left most 2024VOM-2 module is assigned to outputs 1 - 4, the next for outputs 5 - 8, etc. See Figure 22, Video Output Module, page 9.

Using high grade RG-59U video cables, connect the top most BNC from bay 1 on the 2010DB-11 panel, numbered 1, to the 2024VOM-2 in bay 5, for output 1, matching icon to icon. 

Continue in this manner until connections 1 - 4 of the 2010DB-11 panel are connected to inputs 1 - 4 of the first 2024VOM-2. Proceed to the next group of four BNCs on the 2010DB-11 and connect these to the second 2024VOM-2 for outputs 5-8. Continue in this manner until all 16 connections of the 2010DB-11 panel are connected to the 2024VOM-2s for outputs 1 - 16.

Connect the top most BNC from bay 2 on the 2010DB-21 panel, numbered 1, to the 2024VOM-2 in bay 5, for output 1, matching icon to icon. 

Continue in this manner until connections 1 - 4 of the 2010DB-21 panel are connected to inputs 1 - 4 of the 2024VOM-2. Proceed to the next group of four BNCs on the 2010DB-21 and connect these to the second 2024VOM-2 for outputs 5-8. Continue in this manner until all 16 connections of the 2010DB-21 panel are connected to the 2024VOM-2s for outputs 1 - 16.

Connect the top most BNC from bay 3 on the 2010DB-31 panel, numbered 1, to the 2024VOM-2 in bay 5, for output 1, matching icon to icon. 

Continue in this manner until connections 1 - 4 of the 2010DB-31 panel are connected to inputs 1 - 4 of the 2024VOM-2. Proceed to the next group of four BNCs on the 2010DB-31 and connect these to the second 2024VOM-2 for outputs 5-8. Continue in this manner until all 16 connections of the 2010DB-31 panel are connected to the 2024VOM-2s for outputs 1 - 16.

Connect the top most BNC from bay 4 on the 2010DB-41 panel, numbered 1, to the 2024VOM-2 in bay 5, for output 1, matching icon to icon. 

Continue in this manner until connections 1 - 4 of the 2010DB-41 panel are connected to inputs 1 - 4 of the 2024VOM-2. Proceed to the next group of four BNCs on the 2010DB-41 and connect these to the second 2024VOM-2 for outputs 5-8. Continue in this manner until all 16 connections of the 2010DB-41 panel are connected to the 2024VOM-2s for outputs 1-16.

See Appendix Figure A18, Video Interconnections, for illustration of these interconnections.

If there are less than four 2024VOM-2 modules in the system the remaining BNCs on the 2010DB-XX do not require any connection.

## SYSTEM CONFIGURATIONS

---

**Video Input Connections:** See LEVEL 1 - 448 X 16, Two Bay System and connect in a similar manner.

**Video Output Connections:** Each 2024VOM-2 has a rear panel with 20 BNCs. The right most module is assigned to outputs 1-4. The next module is for outputs 5-8, etc. (The modules are numbered 1-4, 5-8, etc.) Connect video outputs to any device that accepts standard video such as monitors or video recorders.



**LEVEL 2 SYSTEMS**

Level 2 systems use up to nine matrix switching bays each with the 2010PS Power Supply Module and either the 2010DB or the 2010DBVL Data Buffer Module. Depending on the configuration, either 2010R Standard bays or 2020R Condensed bays are used in Level 2 systems. Level 2 systems can consist of a maximum of 1024 video inputs as well as a maximum of 32 video outputs (31 outputs if the 2010DBVL module is used).

For a Level 2 system with Video Loss Detection capability, the video output for monitor 32 is replaced by the Video Loss Detection function in the 2010DBVL Module. Since each 2010DBVL can detect video losses for a maximum of 256 cameras, an additional 2010DBVL Module is required for each block of 256 cameras. The camera bays that contain buffered video outputs for monitors 17 through 31 would use a 2010DBVL-12, a 2010DBVL-22, a 2010DBVL-32 and a 2010DBVL-42 for each respective group of 256 cameras. In a system that includes Condensed bays, the Condensed bay that contains outputs 17 to 31 would use the 2010DBVL-00 Module. In a multi-bay system where the last bay contains both camera modules and monitor modules, that bay would use a 2010DBVL-00 module. Any bay that contains only monitor modules uses the 2010DB, not the 2010DBVL Module.

**LEVEL 2 - 64 X 32, One Bay System**

The single bay Level 2 system uses one 2020R matrix Condensed bay. From the rear of the bay, the modules are installed at the factory in the following manner; the far right module is the 2010PS; the next module is the 2010DB-00, followed by one to four 2016AVIM-2 modules and one to four 2024VOM-1 modules, for outputs 17 to 32. The next modules to the left are the one to four 2016AVIM-3 modules, followed by the one to four 2024VOM-1 modules, for outputs 1 to 16.

Smaller matrices, such as those ordered with future expansion in mind, may have fewer modules installed.

**IDENTIFY THESE MODULES CAREFULLY BEFORE PROCEEDING.**

**Data Interconnect:** Connect a 75-ohm coaxial cable from the DATA LINE-1 output on the AD1024 CPU, to the Data IN BNC on the 2010PS rear panel. Connect a 75-ohm BNC terminator (supplied with the CPU) to the Data Out BNC on Power Supply rear panel.

**Video Input Connections:** The 2016AVIM-2 is identified with the camera input icon



The starting camera number for the particular VIM is located at the top BNC. Each 2016AVIM-2 includes eight BNCs for video input connections, a coaxial ribbon connector, labeled OUT, for video interconnection, and one 16 conductor coaxial video cable. See Figure 17, Video Input Module, page 8.

The 2016AVIM-3 is identified with the camera input icon. The starting camera number for the particular VIM is located at the top BNC. Each 2016AVIM-3 includes eight BNCs for video input connections, two coaxial ribbon connectors, labeled IN and OUT and one 75 ohm terminator. See Figure 18, Video Input Module, page 8.

Connect one end of the supplied coaxial ribbon cable to the coaxial ribbon connector labeled "OUT" of the 2016AVIM-2.

**NOTE: Tighten the two connector screws alternately to keep the connectors aligned. Tightening on one side only may damage the connector. Alternate turns between each side.**

Connect the other end of the coaxial ribbon cable to the coaxial ribbon connector labeled "IN" of the 2016AVIM-3 following the alternating turn method noted above. Place a 75-ohm terminator (P/N 2016 TERM) in the coaxial ribbon connector labeled "OUT" of the 2016AVIM-3. Continue in this manner for each 2016AVIM pair. A pair meaning the upper and lower halves of multiples of 16; for example, 1 to 8 and 9 to 16 being a pair, 17 to 24 and 25 to 32 being a pair.

In succession, connect the video inputs to the 2016AVIM-2 and 2016AVIM-3 module pairs. Connect eight video inputs to 2016AVIM-2 and the next eight video inputs to 2016AVIM-3. Continue in this fashion until all video inputs are connected. Unused video inputs do not require any external connection or termination, and may be left open.

**Video Output Connections:** Each 2024VOM-1 has a rear panel with 16 BNCs. The left most module is assigned to outputs 1-4. Moving left to right, the next module is for outputs 5-8, the next module is for outputs 9-12, the next for outputs 13-16. Continuing left, the next four positions are for 2016AVIM modules. The following four positions are for video outputs 17-32. Connect the video outputs to any device that accepts standard video such as monitors or video recorders.

In the Appendix, see Figure A6, 64 X 32, One Bay System.

## SYSTEM CONFIGURATIONS

---

### LEVEL 2 - 192 X 32, Two Bay System

A two bay, Level 2 system allows a maximum of 192 video inputs switched to a maximum 32 video outputs. Bay one consists of 192 video inputs with the first group of 16 video outputs. Bay two consists of the same 192 video inputs with the second group of 16 video outputs.

From the rear of bay one, the modules are installed at the factory in the following manner; the far right module is the 2010PS, the next module is the 2010DB-00, followed by twelve 2016AVIM-2 modules for inputs 1 - 192, and four 2024VOM-1 modules for outputs 1 - 16.

From the rear of bay two, the modules are installed at the factory in the following manner; the far right module is the 2010PS, the next module is the 2010DB-00, followed by twelve 2016AVIM-3 modules for inputs 1 - 192, and four 2024VOM-1 modules for outputs 17 - 32.

Smaller matrices, such as those ordered with future expansion in mind, may have fewer modules installed.

#### **IDENTIFY THESE MODULES CAREFULLY BEFORE PROCEEDING.**

**Data Interconnect:** Connect a 75-ohm coaxial cable from the DATALINE-1 output on the AD1024 CPU, to the DATA IN BNC of Bay 1. Connect a 75-ohm coaxial cable from the DATA OUT BNC of bay 1 to the DATA IN BNC 2010PS rear panel of Bay 2. Connect a 75 ohm BNC terminator (supplied with the CPU) to the DATA OUT BNC of Bay 2.

**Video Input Connections:** The 2016AVIM-2 is identified with the camera input icon.



The starting camera number for the particular VIM is located at the top BNC. Each 2016AVIM-2 includes eight BNCs for video input connections, a coaxial ribbon connector, labeled OUT, for video interconnection, and one 16 conductor coaxial ribbon cable. See Figure 17, Video Input Module, page 8.

The 2016AVIM-3 is identified with the camera input icon. The starting camera number for the particular VIM is located at the top BNC. Each 2016AVIM-3 includes eight BNCs for video input connections, two coaxial ribbon connectors, labeled IN and OUT and one 75 ohm terminator. See Figure 18, Video Input Module, page 8.

Connect one end of the supplied coaxial ribbon cable to the coaxial ribbon connector labeled "OUT" of the 2016AVIM-2.

**NOTE: Tighten the two connector screws alternately to keep the connectors aligned. Tightening on one side only may damage the connector. Alternate turns between each side.**

Connect the other end of the coaxial ribbon cable to the coaxial ribbon connector labeled "IN" of the 2016AVIM-3 following the alternating turn method noted above. Place a 75-ohm terminator (P/N 2016 TERM) in the coaxial ribbon connector labeled "OUT" of the 2016AVIM-3. Continue in this manner for each 2016AVIM pair. A pair meaning the upper and lower halves of multiples of 16; for example, 1 to 8 and 9 to 16 being a pair, 17 to 24 and 25 to 32 also being a pair.

In succession, connect the video inputs to the 2016AVIM-2 and 2016AVIM -3 module pairs. Connect eight video inputs to 2016AVIM-2 and the next eight video inputs to 2016AVIM-3. Continue in this fashion until all video inputs are connected. Unused video inputs do not require any external connection or termination, and may be left open.

**Video Output Connections:** Each 2024VOM-1 has a rear panel with 16 BNCs. The bottom four BNCs are used for video output connections. The right most module is assigned to outputs 1 - 4, the next for outputs 5 - 8, etc (The modules are numbered 1 - 4, 5 - 8 etc.). Connect the video outputs to any device that accepts standard video such as monitors or video recorders. Bay one contains the 2024VOM modules for outputs 1-16, bay two for outputs 17-32.

In the Appendix, see Figure A7, 192 X 32, Two Bay System.

**LEVEL 2 - 320 X 32, Three Bay System**

A three bay, Level 2 system allows a maximum of 320 video inputs switched to a maximum 32 video outputs. Bay one consists of 256 video inputs for the first 16 video outputs and bay two consists of 256 video inputs for the second group of 16 video outputs. Bay three, a 2020R Condensed bay, consists of 64 video inputs for both groups of outputs.

From the rear of bay one, the modules are installed at the factory in the following manner; the far right module is the 2010PS, the next module is the 2010DB-11 with 16 BNCs for connection to the 2024VOM-1 modules in bay three, followed by sixteen 2016AVIM-2 modules, inputs 1 - 256.

From the rear of bay two, the modules are installed at the factory in the following manner; the far right module is the 2010PS, the next module is the 2010DB-12 with 16 BNCs for connection to the 2024VOM-1 modules in bay three, followed by sixteen 2016AVIM-3 modules, inputs 1 - 256.

From the rear of bay three, the modules are installed at the factory in the following manner; the far right module is the 2010PS; the next module is the 2010DB-00, followed by four 2016AVIM-2 modules for inputs 257 - 320, and four 2024VOM-1 modules for outputs 17 to 32. The next modules to the left are four 2016AVIM-3 modules for inputs 257 - 320, followed by four 2024VOM-1 modules for outputs 1 to 16.

Smaller matrices, such as those ordered with future expansion in mind, may have fewer modules installed.

**IDENTIFY THESE MODULES CAREFULLY BEFORE PROCEEDING.**

**Data Interconnect:** See Level 2, 192 X 32, two bay system. Connect all bays in a similar manner.

**Video Interconnections:** The 16 video outputs from bay 1, located on the rear panel of the 2010DB-11, are grouped by fours and identified by the icon. ◀▶

On bay 3, each 2024VOM-1 is similarly grouped with three sections of four BNCs, with identifying icons. A fourth section of four BNCs is used for video output connections. See Figure 21, Video Output Module, page 9.

Using high grade RG-59U video cables, connect the topmost BNC from bay 1 on the 2010DB-11 panel, numbered 1, to the top-most input BNC, labeled 1 for the 2024VOM-1 in bay 3, for output 1, matching icon to icon. ◀▶

Continue in this manner until connections 1-4 of the 2010DB-11 panel are connected to inputs 1-4 of the first 2024VOM-1. Proceed to the next group of four BNCs on the 2010DB-11 of the first bay and connect these four to the second 2024VOM-1 for outputs 5-8. Continue in this manner until all 16 connections of the 2010DB-11 panel are connected to the 2024VOM-1 modules.

Connect bay 2 in a similar manner to the 2024 VOM-1 modules of bay 3 for video outputs 17-32, matching icon to icon. ◀▶

See Appendix Figure A18, Video Interconnections, for illustration of these connections.

If there are less than eight 2024VOM-1 modules in the system the remaining BNCs on the 2010DB-XX do not require any connection.

**Video Input Connections:** See LEVEL 2 - 192 X 32, Two Bay System and connect in a similar manner.

**Video Output Connections:** See LEVEL 2 - 192 X 32, Two Bay System and connect in a similar manner.

In the Appendix, see Figure A8, 448 X 32, Four Bay System.

## SYSTEM CONFIGURATIONS

---

### LEVEL 2 - 448 X 32, Four Bay System

A four bay, Level 2 system allows a maximum of 448 video inputs switched to a maximum 32 video outputs. Bay one consists of 256 video inputs, bay two consists of 192 video inputs with the first group of 16 video outputs. Bay three consists of 256 video inputs, bay four consists of 192 video inputs with the second group of 16 video outputs.

From the rear of bay one, the modules are installed at the factory in the following manner; the far right module is the 2010PS, the next module is the 2010DB-11 with 16 BNCs for connection to the 2024VOM-1 modules in bay two, followed by sixteen 2016AVIM-2 modules, inputs 1 - 256.

From the rear of bay two, the modules are installed at the factory in the following manner; the far right module is the 2010PS, the next module is the 2010DB-00, followed by twelve 2016AVIM-2 modules for inputs 257 - 448, and four 2024VOM-1 modules for outputs 1 - 16.

From the rear of bay three, the modules are installed at the factory in the following manner; the far right module is the 2010PS, the next module is the 2010DB-12 with 16 BNCs for connection to the 2024VOM-1 modules in bay four, followed by sixteen 2016AVIM-3 modules, inputs 1 - 256.

From the rear of bay four, the modules are installed at the factory in the following manner; the far right module is the 2010PS, the next module is the 2010DB-00, followed by twelve 2016AVIM-3 modules for inputs 257 - 448, and four 2024VOM-1 modules for outputs 17 - 32.

Smaller matrices, such as those ordered with future expansion in mind, may have fewer modules installed.

#### **IDENTIFY THESE MODULES CAREFULLY BEFORE PROCEEDING.**

**Data Interconnect:** See Level 2, 192 X 32, two bay system. Connect all bays in a similar manner.

**Video Interconnections:** The 16 video outputs from bay 1, and bay 3 located on the rear panel of the 2010DB-11, and 2010DB-12, are grouped by fours and identified by the icon. ◀▶

Each 2024VOM-1 is similarly grouped with three sections of four BNCs, with identifying icons. A fourth section of four BNCs is used for video output connections. See Figure 21, Video Output Module, page 9.

Using high grade RG-59U video cables, connect the topmost BNC from bay 1 on the 2010DB-11 panel, numbered 1, to the topmost input BNC, labeled 1 for the 2024VOM-1 in bay 2, for output 1, matching icon to icon. ◀▶

Continue in this manner until connections 1-4 of the 2010DB-11 panel are connected to inputs 1-4 of the first 2024VOM-1. Proceed to the next group of four BNCs on the 2010DB-11 of the first bay and connect these four to the second 2024VOM-1 for outputs 5-8. Continue in this manner until all 16 connections of the 2010DB-11 panel are connected to all of the 2024VOM-1 modules.

Connect bay 3 in a similar manner to the 2024VOM-1 modules of bay 4 for video outputs 17-32, matching icon to icon. ◀▶

See Appendix Figure A18, Video Interconnections, for illustration of these connections.

If there are less than eight 2024VOM-1 modules in the system the remaining BNCs on the 2010DR-XX do not require any connection.

**Video Input Connections:** See LEVEL 2 - 192 X 32, Two Bay System and connect in a similar manner.

**Video Output Connections:** See LEVEL 2 - 192 X 32, Two Bay System and connect in a similar manner.

In the Appendix, see Figure A9, 448 X 32, Four Bay System.

**LEVEL 2 - 704 X 32, Six Bay System**

A six bay, Level 2 system allows a maximum of 704 video inputs switched to a maximum 32 video outputs. Bays one and two each consist of 256 video inputs. Bay three consists of 192 video inputs with the first group of 16 video outputs. Bays four and five also each consist of 256 video inputs. Bay six consists of 192 video inputs with the second group 16 video outputs.

From the rear of bay one, the modules are installed at the factory in the following manner; the far right module is the 2010PS, the next module is the 2010DB-11 with 16 BNCs for connection to the 2024VOM-1 modules in bay three, followed by sixteen 2016AVIM-2 modules, inputs 1 - 256.

From the rear of bay two, the modules are installed at the factory in the following manner; the far right module is the 2010PS, the next module is the 2010DB-21 with 16 BNCs for connection to the 2024VOM-1 modules, in bay three followed by sixteen 2016AVIM-2 modules, inputs 257 - 512.

From the rear of bay three, the modules are installed at the factory in the following manner; the far right module is the 2010PS, the next module is the 2010DB-00, followed by twelve 2016AVIM-2 modules for inputs 513 - 704, and four 2024VOM-1 modules for outputs 1 - 16.

From the rear of bay four, the modules are installed at the factory in the following manner; the far right module is the 2010PS, the next module is the 2010DB-12 with 16 BNCs for connection to the 2024VOM-1 modules in bay six, followed by sixteen 2016AVIM-3 modules, inputs 1 - 256.



From the rear of bay five, the modules are installed at the factory in the following manner; the far right module is the 2010PS, the next module is the 2010DB-22 with 16 BNCs for connection to the 2024VOM-1 modules in bay six, followed by sixteen 2016AVIM-3 modules, inputs 257 - 512.

From the rear of bay six, the modules are installed at the factory in the following manner; the far right module is the 2010PS, the next module is the 2010DB-00, followed by twelve 2016AVIM-3 modules for inputs 513 - 704, and four 2024VOM-1 modules for outputs 17 - 32.

Smaller matrices such as those ordered with future expansion in mind, may have fewer modules installed.

**IDENTIFY THESE MODULES CAREFULLY  
BEFORE PROCEEDING.**

**Data Interconnect:** See LEVEL 2 - 192 X 32, two bay system and connect all the bays in a similar manner.

**Video Interconnections:** The 16 video outputs from bay 1, bay 2, bay 4, and bay 5 located on the rear panel of the 2010DB-11, 2010DB-12 , 2010DB-21, and 2010DB-22 , are grouped by fours and identified by their icons.

Each 2024VOM-1 is similarly grouped with three sections of four BNCs, with identifying icons. A fourth section of four BNCs is used for video output connections. See Figure 21, Video Output Module, page 9.

Using high grade RG-59U video cables, connect the topmost BNC from bay 1 on the 2010DB-11 panel, numbered 1, to the topmost input BNC, labeled 1 for the 2024VOM-1 in bay 3, for output 1, matching icon to icon. 

Continue in this manner until connections 1-4 of the 2010DB-11 panel are connected to inputs 1-4 of the first 2024VOM-1. Proceed to the next group of four BNCs on the 2010DB-11 of the first bay and connect these four to the second 2024VOM-1 for outputs 5-8. Continue in this manner until all 16 connections of the 2010DB-11 panel are connected to all of the 2024VOM-1 modules. 

Connect bay 2 in a similar manner to the 2024VOM-1 modules of bay 3, for video outputs 1-16, matching icon to icon. 

Connect bay 4 in a similar manner to the 2024VOM-1 modules of bay 6 for video outputs 17-32, matching icon to icon. 

Connect bay 5 in a similar manner to the 2024VOM-1 modules of bay 6 for video outputs 17-32, matching icon to icon. 

See Appendix Figure A18, Video Interconnections, for illustration of these connections.

If there are less than eight 2024VOMs in the system the remaining BNCs on the 2010DR-XX do not require any connection.

**Video Input Connections:** See LEVEL 2 - 192 X 32, Two Bay System and connect in a similar manner.

**Video Output Connections:** See LEVEL 2 - 192 X 32, Two Bay System and connect in a similar manner.

In the Appendix, see Figure A10, LEVEL 2 - 704 X 32, Six Bay System.

## SYSTEM CONFIGURATIONS

### LEVEL 2 - 960 X 32, Eight Bay System.

An eight bay, Level 2 system allows a maximum of 960 video inputs switched to a maximum 32 video outputs. Bays one, two, and three each consist of 256 video inputs. Bay four consists of 192 video inputs with the first group 16 video outputs. Bays five, six, and seven also each consist of 256 video inputs. Bay eight consists of 192 video inputs with the second group 16 video outputs.

From the rear of bay one, the modules are installed at the factory in the following manner; the far right module is the 2010PS, the next module is the 2010DB-11 with 16 BNCs for connection to the 2024VOM-1 modules in bay four, followed by sixteen 2016AVIM-2 modules, inputs 1 - 256.

From the rear of bay two, the modules are installed at the factory in the following manner; the far right module is the 2010PS, the next module is the 2010DB-21 with 16 BNCs for connection to the 2024VOM-1 modules in bay four, followed by sixteen 2016AVIM-2 modules, inputs 257 - 512.

From the rear of bay three, the modules are installed at the factory in the following manner; the far right module is the 2010PS, the next module is the 2010DB-31 with 16 BNCs for connection to the 2024VOM-1 modules in bay four, followed by sixteen 2016AVIM-2 modules, inputs 513 - 768.

From the rear of bay four, the modules are installed at the factory in the following manner; the far right module is the 2010PS, the next module is the 2010DB-00, followed by twelve 2016AVIM-2 modules, inputs 769 - 960, and four 2024VOM-1 modules for outputs 1 - 16.

From the rear of bay five, the modules are installed at the factory in the following manner; the far right module is the 2010PS, the next module is the 2010DB-12 with 16 BNCs for connection to the 2024VOM-1 modules in bay eight, followed by sixteen 2016AVIM-3 modules, inputs 1 - 256.

From the rear of bay six, the modules are installed at the factory in the following manner; the far right module is the 2010PS, the next module is the 2010DB-22 with 16 BNCs for connection to the 2024VOM-1 modules in bay eight, followed by sixteen 2016AVIM-3 modules, inputs 257 - 512.



From the rear of bay seven, the modules are installed at the factory in the following manner; the far right module is the 2010PS, the next module is the 2010DB-32 with 16 BNCs for connection to the 2024VOM-1 modules in bay eight, followed by sixteen 2016AVIM-3 modules, inputs 513 - 768.

From the rear of bay eight, the modules are installed at the factory in the following manner; the far right module is the 2010PS, the next module is the 2010DB-00, followed by twelve 2016AVIM-3 modules, inputs 769 - 960, and four 2024VOM-1 modules for outputs 17 - 32.

Smaller matrices such as those ordered with future expansion in mind, may have fewer modules installed.

### IDENTIFY THESE MODULES CAREFULLY BEFORE PROCEEDING.

**Data Interconnect:** See LEVEL 2 - 192 X 32, Two Bay System and connect all bays in a similar manner.

**Video Interconnections:** The 16 video outputs from bay 1, bay 2, bay 3 and bay 5, bay 6, and bay 7 located on the rear panel of the 2010DB-11, 2010DB-12 , 2010DB-21, 2010DB-22 , 2010DB-31, and 2010DB-32  are grouped by fours and identified by their icons.

Each 2024VOM-1 is similarly grouped with three sections of four BNCs, with identifying icons. A fourth section of four BNCs is used for video output connections. See Figure 21, Video Output Module, page 9.

Using high grade RG-59U video cables, connect the top most BNC from bay 1 on the 2010DR-11 panel, numbered 1, to the top most input BNC, labeled 1 for the 2024VOM-1 in bay 4, for output 1, matching icon to icon. 

Continue in this manner until connections 1-4 of the 2010DB-11 panel are connected to inputs 1-4 of the first 2024VOM-1. Proceed to the next group of four BNCs on the 2010DB-11 of the first bay and connect these four to the second 2024VOM-1 for outputs 5-8. Continue in this manner until all 16 connections of the 2010DB-11 panel are connected to all of the 2024VOM-1 modules.

Connect bay 2 in a similar manner to the 2024VOM-1 modules of bay 4 for video outputs 1-16, matching icon to icon. 

Connect bay 3 in a similar manner to the 2024VOM-1 modules of bay 4 for video outputs 1-16, matching icon to icon. 

Connect bay 5 in a similar manner to the 2024VOM-1 modules of bay 8 for video outputs 17-32, matching icon to icon. 

Connect bay 6 in a similar manner to the 2024VOM-1 modules of bay 8 for video outputs 17-32, matching icon to icon. 

Connect bay 7 in a similar manner to the 2024VOM-1 modules of bay 8 for video outputs 17-32, matching icon to icon. 

See Appendix Figure A18, Video Interconnections, for illustration of these connections.

If there are less than eight 2024VOMs in the system the remaining BNCs on the 2010DB-XX do not require any connection.

**Video Input Connections:** See LEVEL 2 - 192 X 32, Two Bay System and connect in a similar manner.

**Video Output Connections:** See LEVEL 2 - 192 X 32, Two Bay System and connect in a similar manner.

In the Appendix, see Figure A11, Level 2 - 960 X 32, Eight Bay System.

## SYSTEM CONFIGURATIONS

### LEVEL 2 - 1024 X 32, Nine Bay System

A nine bay, Level 2 system allows a maximum of 1024 video inputs switched to a maximum 32 video outputs. Bays one through eight each consists of 256 video inputs, and bay nine consists of the first 32 video outputs.

From the rear of bay one, the modules are installed at the factory in the following manner; the far right module is the 2010PS, the next module is the 2010DB-11 with 16 BNCs for connection to the 2024VOM-1 modules in bay nine, followed by sixteen 2016AVIM-2 modules, inputs 1 - 256.

From the rear of bay two, the modules are installed at the factory in the following manner; the far right module is the 2010PS, the next module is the 2010DB-21 with 16 BNCs for connection to the 2024VOM-1 modules in bay nine, followed by sixteen 2016AVIM-2 modules, inputs 257 - 512.

From the rear of bay three, the modules are installed at the factory in the following manner; the far right module is the 2010PS, the next module is the 2010DB-31 with 16 BNCs for connection to the 2024VOM-1 modules in bay nine, followed by sixteen 2016AVIM-2 modules, inputs 513 - 768.

From the rear of bay four, the modules are installed at the factory in the following manner; the far right module is the 2010PS, the next module is the 2010DB-41 with 16 BNCs for connection to the 2024VOM-1 modules in bay nine, followed by sixteen 2016AVIM-2 modules, inputs 769 - 1024.

From the rear of bay five, the modules are installed at the factory in the following manner; the far right module is the 2010PS, the next module is the 2010DB-12 with 16 BNCs for connection to the 2024VOM-1 modules in bay nine, followed by sixteen 2016AVIM-3 modules, inputs 1 - 256.

From the rear of bay six, the modules are installed at the factory in the following manner; the far right module is the 2010PS, the next module is the 2010DB-22 with 16 BNCs for connection to the 2024VOM-1 modules in bay nine, followed by sixteen 2016AVIM-3 modules, inputs 257 - 512.

From the rear of bay seven, the modules are installed at the factory in the following manner; the far right module is the 2010PS, the next module is the 2010DB-32 with 16 BNCs for connection to the 2024VOM-1 modules in bay nine, followed by sixteen 2016AVIM-3 modules, inputs 513 - 768.



From the rear of bay eight, the modules are installed at the factory in the following manner; the far right module is the 2010PS, the next module is the 2010DB-42 with 16 BNCs for connection to the 2024VOM-1 modules in bay nine, followed by sixteen 2016AVIM-3 modules, inputs 769-1024.

From the rear of bay nine, the modules are installed at the factory in the following manner; the far right module is the 2010PS, the next module is the 2010DB-00, followed by eight 2024VOM-2 modules, installed left to right, for outputs 1 - 32.

Smaller matrices such as those ordered with future expansion in mind, may have fewer modules installed.

### IDENTIFY THESE MODULES CAREFULLY BEFORE PROCEEDING.

**Data Interconnect:** See LEVEL 2 - 192 X 32, Two Bay System and connect all bays in a similar manner.

**Video Interconnections:** The 16 video outputs from bay 1, bay 2, bay 3 and bay 5, bay 6, and bay 7 located on the rear panel of the 2010DB-11, 2010DB-12  , 2010DB-21, 2010DB-22  , 2010DB-31, and 2010DB-32  are grouped by fours and identified by their icons.

Each 2024VOM-2 is similarly grouped with four sections of four BNCs, with identifying icons. A fifth section of four BNCs, in the lower left corner, is used for video outputs. The left most 2024VOM-2 module is assigned to outputs 1 - 4, the next for outputs 5 - 8, etc. See Figure 22, Video Output Module, page 9.

Using high grade RG-59U video cables, connect the topmost BNC from bay 1 on the 2010DB-11 panel, numbered 1, to the 2024VOM-2 in bay 9, for output 1, matching icon to icon. 

Continue in this manner until connections 1-4 of the 2010DB-11 panel are connected to inputs 1-4 of the first 2024VOM-2. Proceed to the next group of four BNCs on the 2010DB-11 and connect these to the second 2024VOM-2 for outputs 5-8. Continue in this manner until all 16 connections of the 2010DB-11 panel are connected to the 2024VOM-2 modules for outputs 1 - 16.

Connect bay 5 in a similar manner to the 2024VOM-2 modules of bay 9 for video outputs 17 - 32, matching icon to icon. 

Connect the top most BNC from bay 2 on the 2010DB-21 panel, numbered 1, to the 2024VOM-2 in bay 9, for output 1, matching icon to icon. 

Continue in this manner until connections 1-4 of the 2010DB-21 panel are connected to inputs 1-4 of the 2024VOM-2. Proceed to the next group of four BNCs on the 2010DB-21 and connect these to the second 2024VOM-2 for outputs 5-8. Continue in this manner until all 16 connections of the 2010DB-21 panel are connected to the 2024VOM-2 modules for outputs 1-16.

Connect bay 6 in a similar manner to the 2024VOM-2 modules of bay 9 for video outputs 17-32, matching icon to icon. 



Connect the topmost BNC from bay 3 on the 2010DB-31 panel, numbered 1, to the 2024VOM-2 in bay 9, for output 1, matching icon to icon. 

Continue in this manner until connections 1-4 of the 2010DB-31 panel are connected to inputs 1-4 of the 2024VOM-2. Proceed to the next group of four BNCs on the 2010DB-31 and connect these to the second 2024VOM-2 for outputs 5-8. Continue in this manner until all 16 connections of the 2010DB-31 panel are connected to the 2024VOM-2 modules for outputs 1-16.

Connect bay 7 in a similar manner to the 2024VOM-2 modules of bay 9 for video outputs 17-32, matching icon to icon. 

Connect the top most BNC from bay 4 on the 2010DB-41 panel, numbered 1, to the 2024VOM-2 in bay 9, for output 1, matching icon to icon. 

Continue in this manner until connections 1-4 of the 2010DB-41 panel are connected to inputs 1-4 of the 2024VOM-2. Proceed to the next group of four BNCs on the 2010DB-41 and connect these to the second 2024VOM-2 for outputs 5-8. Continue in this manner until all 16 connections of the 2010DB-41 panel are connected to the 2024VOM-2 modules for outputs 1 - 16.

Connect bay 8 in a similar manner to the 2024VOM-2 modules of bay 9 for video outputs 17 - 32, matching icon to icon. 

See Appendix Figure A18, Video Interconnections, for illustration of these connections.

If there are less than eight 2024VOM-2 modules in the system the remaining BNCs on the 2010DB-XX do not require any connection.

**Video Input Connections:** See LEVEL 2 - 192 X 32, Four Bay System and connect all bays in a similar manner.

**Video Output Connections:** Each 2024VOM-2 has a rear panel with 20 BNCs. The right most module is assigned to outputs 1-4. The next module is for outputs 5-8, etc. (The modules are numbered 1-4, 5-8, etc.) Connect video outputs to any device that accepts standard video such as monitors or video recorders.

## SYSTEM CONFIGURATIONS

### LEVEL 3 SYSTEMS

Level 3 systems use up to fourteen 2010 matrix switching bays each with the 2010PS Power Supply Module and 2010DB-XX Data Buffer module. Level 3 systems can consist of up to 192, 448, 704, 768, 960, or 1024 video inputs and up to 48 video outputs, arranged as 2, 3, 4, 6, 7, 9, 10, 12, and 14 bay systems.

For a Level 3 system with Video Loss Detection capability, the video output for monitor 48 is replaced by the Video Loss Detection function in the 2010DBVL Module. Since each 2010DBVL can detect video losses for a maximum of 256 cameras, an additional 2010DBVL Module is required for each block of 256 cameras. The camera bays that contain video outputs for monitors 32 through 47 would use a 2010DBVL-13, a 2010DBVL-23, a 2010DBVL-33 and a 2010DBVL-43 for each respective group of 256 cameras. In a multi-bay system where the last bay contains both camera modules and monitor modules, that bay would use a 2010DBVL-00 module. In a fourteen-bay system, the last two bays are monitor bays and would use the 2010DB-00 Module, not the 2010DBVL.

#### LEVEL 3 - 192 X 48, Three Bay System

A three bay, Level 3 Systems allows a maximum of 192 video inputs switched to a maximum 48 video outputs. Bay one consists of 192 video inputs switched to video outputs 1-16, bay two consists of 192 video inputs switched to video outputs 17-32 and bay 3 consists of 192 video inputs switched to video outputs 33-48.

From the rear of bay one, the modules are installed at the factory in the following manner; the far right module is the 2010PS, the next module is the 2010DB-00, followed by twelve 2016AVIM-2 modules and four 2024VOM-1 modules, inputs 1-192, outputs 1-16.

From the rear of bay two, the modules are installed at the factory in the following manner; the far right module is the 2010PS, the next module is the 2010DB-00, followed by twelve 2016AVIM-3 modules and four 2024VOM-1 modules, inputs 1-192, outputs 17-32.

From the rear of bay three, the modules are installed at the factory in the following manner; the far right module is the 2010PS, the next module is the 2010DB-00, followed by twelve 2016AVIM-4 modules and four 2024VOM-1 modules, inputs 1-192, outputs 33-48.

#### IDENTIFY THESE MODULES CAREFULLY BEFORE PROCEEDING.

**Data Interconnect:** Connect a 75-ohm coaxial cable from the DATALINE-1 output on the AD1024 CPU, to the DATA IN BNC of bay 1. Connect a 75-ohm coaxial cable from the DATA OUT BNC of bay 1 to the DATA IN BNC on the

2010PS rear panel in bay 2. Connect a 75-ohm coaxial cable from the DATA OUT BNC of bay 2 to the DATA IN BNC 2010PS rear panel in bay 3. Connect a 75 ohm BNC terminator (supplied with the CPU) to the Data OUT BNC of bay 3.

**Video Input Connections:** The 2016AVIM-2 is identified with the camera input icon.



The starting camera number for the particular VIM is located at the top BNC. Each 2016AVIM-2 includes 8 BNCs for video input connections, a coaxial ribbon connector, labeled OUT, for video interconnection, and one 16 conductor coaxial ribbon cable. See Figure 17, Video Input Module, page 8.

The 2016AVIM-3 is identified with the camera input icon. The starting camera number for the particular VIM is located at the top BNC. Each 2016AVIM-3 includes 8 BNCs for video input connections, two coaxial ribbon connectors, labeled IN and OUT and one 75 ohm terminator. See Figure 18, page 9.

The 2016AVIM-4 is identified with the camera input icon. The starting camera number for the particular VIM is located at the top of rear panel. Each 2016AVIM-4 includes two coaxial ribbon connectors, labeled IN and OUT, for video interconnection, and one 16 conductor coaxial ribbon cable.

Connect one end of the supplied coaxial ribbon cable to the coaxial ribbon connector labeled "OUT" of the 2016AVIM-2.

**NOTE: Tighten the two connector screws alternately to keep the connectors aligned. Tightening on one side only may damage the connector. Alternate between each side.**

Connect the other end of the coaxial ribbon cable to the coaxial ribbon connector labeled "IN" of the 2016AVIM-3 following the alternating turn method noted above. Connect one end of the second coaxial ribbon cable supplied with the 2016AVIM-4 to the coaxial ribbon connector labeled OUT of the 2016AVIM-3. Connect the other end of the ribbon cable to the coaxial ribbon connector labeled IN of the 2016AVIM-4 following the alternating turn method above. Place a 75 ohm terminator (P/N2016 TERM) in the coaxial ribbon connector labeled OUT of the 2016AVIM-4. Continue in this manner for each 2016AVIM pair. A pair meaning the upper and lower halves of multiples of 16; for example, 1 to 8 and 9 to 16 being a pair, 17 to 24 and 25 to 32 also being a pair.

In succession, connect the video inputs to the 2016AVIM-2 and 2016AVIM -3 module pairs. Connect eight video inputs to 2016AVIM-2 and the next eight video inputs to 2016AVIM-3. Continue in this fashion until all video inputs are connected.

Unused video inputs do not require any external connection or termination, and may be left open.

**Video Output Connections:** Each 2024VOM-1 has a rear panel with 16 BNCs. The bottom four BNCs are used for video output connections. The left-most module is assigned to outputs 1-4, the next for outputs 5-7, etc. Connect the video outputs to any device that accepts standard video such as monitors or video recorders. Bay one contains the 2024VOMs for outputs 1-16, bay two for outputs 17-32 and bay three for outputs 33-48.

In the Appendix, see Figure A12, 192 X48, Three Bay System.

### LEVEL 3 - 256 X 48, Four Bay System

A four bay, Level 3 system allows a maximum of 256 video inputs switched to a maximum 48 video outputs. Bays one through three consists of 256 video inputs, and bay four consists of 48 video outputs.

From the rear of bay one, the modules are installed at the factory in the following manner; the far right module is the 2010PS, the next module is the 2010DB-11 with 16 BNCs for connection to the 2024VOM-1 modules in bay four, followed by sixteen 2016AVIM-2 modules, inputs 1-256.

From the rear of bay two, the modules are installed at the factory in the following manner; the far right module is the 2010PS, the next module is the 2010DB-12 with 16 BNCs for connection to the 2024VOM-1 modules in bay four, followed by sixteen 2016AVIM-3 modules, inputs 1-256.

From the rear of bay three, the modules are installed at the factory in the following manner; the far right module is the 2010PS, the next module is the 2010DB-13 with 16 BNCs for connection to the 2024VOM-1 modules in bay four, followed by sixteen 2016AVIM-4 modules, inputs 1-256.

From the rear of bay four, the modules are installed at the factory in the following manner; the far right module is the 2010PS, the next module is the 2010DB-00, followed by twelve 2024VOM-1 modules, installed left to right, for outputs 1-48.

Smaller matrices such as those ordered with future expansion in mind, may have fewer modules installed.

### IDENTIFY THESE MODULES CAREFULLY BEFORE PROCEEDING.

**Data Interconnect:** See LEVEL 3 - 192 X 48, Three Bay System and connect all bays in a similar manner.

**Video Interconnections:** The 16 video outputs from bay 1, bay 2, and bay 3 located on the rear panel of the 2010DB-11, -

12 and -13 respectively, are grouped by fours and identified by the icon. 

Each 2024VOM-1 is similarly grouped with three sections of four BNCs, with identifying icons. A fourth section of four BNCs is used for video output connections. The left-most 2024VOM-1 module is assigned to outputs 1-4, the next for outputs 5-8, etc. See Figure 21, Video Output Module, page 9.

Using high grade RG-59U video cables, connect the topmost BNC from bay 1 on the 2010DB-11 panel, numbered 1, to the 2024VOM-1 in bay 4, for output 1, matching icon to icon . Continue in this manner until connections 1-4 of the 2010DB-11 panel are connected to inputs 1-4 of the first 2024VOM-1. Proceed to the next group of four BNCs on the 2010DB-11 of the first bay and connect these four to the second 2024VOM-1 for outputs 5-8. Continue in this manner until all 16 connections of the 2010DB-11 panel are connected to the 2024VOM-1s for outputs 1 - 16.

Connect the topmost BNC from bay 2 on the 2010DB-12 panel, numbered 17, to the 2024VOM-1 in bay 4, for output 17, matching icon to icon . Continue in this manner until connections 17 - 20 of the 2010DB-12 panel are connected to inputs 17 - 20 of the fifth 2024VOM-1. Proceed to the next group of four BNCs on the 2010DB-12 of the second bay and connect these four to the sixth 2024VOM-1 for outputs 21-24. Continue in this manner until all 16 connections of the 2010DB-12 panel are connected to the 2024VOM-1s for outputs 17 - 32.

Connect the topmost BNC from bay 3 on the 2010DB-13 panel, numbered 33, to the 2024VOM-1 in bay 4, for output 33, matching icon to icon . Continue in this manner until connections 33 - 36 of the 2010DB-13 panel are connected to inputs 33 - 36 of the ninth 2024VOM-1. Proceed to the next group of four BNCs on the 2010DB-13 of the third bay and connect these four to the tenth 2024VOM-1 for outputs 37 - 40. Continue in this manner until all 16 connections of the 2010DB-13 panel are connected to the 2024VOM-1s for outputs 33 - 48.

See Appendix Figure A18, Video Interconnections, for illustration of these connections.

If there are less than twelve 2024VOM-1s in the system the remaining BNCs on the 2010DB-XX do not require any connection.

**Video Input Connections:** See LEVEL 3 - 192 X 48, Three Bay System and connect all bays in a similar manner.

**Video Output Connections:** See LEVEL 3 - 192 X 48, Three Bay System and connect all bays in a similar manner.

In the Appendix, see Figure A13, 256 X 48, Four Bay System.

## SYSTEM CONFIGURATIONS

### LEVEL 3 - 448 X 48, Six Bay System

A six bay, Level 3 systems allows a maximum of 448 video inputs switched to a maximum 48 video outputs. Bay one consists of 256 video inputs, bay two consists of 192 video inputs with the first group 16 video outputs, bay three consists of 256 video inputs, bay four consists of 192 video inputs with the second group 16 video outputs, bay five consists of 256 video inputs, bay six consists of 192 video inputs with the third group 16 video outputs.

From the rear of bay one, the modules are installed at the factory in the following manner; the far right module is the 2010PS, the next module is the 2010DB-11 with 16 BNCs for connection to the 2024VOM-1 modules in bay two, followed by sixteen 2016AVIM-2 modules, inputs 1-256.

From the rear of bay two, the modules are installed at the factory in the following manner; the far right module is the 2010PS, the next module is the 2010DB-00, followed by twelve 2016AVIM-2 modules, inputs 257-448, and four 2024VOM-1 modules, outputs 1-16.

From the rear of bay three, the modules are installed at the factory in the following manner; the far right module is the 2010PS, the next module is the 2010DB-12 with 16 BNCs for connection to the video output modules in bay four, followed by sixteen 2016AVIM-3 modules, inputs 1-256.

From the rear of bay four, the modules are installed at the factory in the following manner; the far right module is the 2010PS, the next module is the 2010DB-00, followed by twelve 2016AVIM-3 modules, inputs 257-448, and four 2024VOM-1 modules, outputs 17-32.

From the rear of bay five, the modules are installed at the factory in the following manner; the far right module is the 2010PS, the next module is the 2010DB-13 with 16 BNCs for connection to the video output modules in bay six, followed by sixteen 2016AVIM-4 modules, inputs 1-256.

From the rear of bay six, the modules are installed at the factory in the following manner; the far right module is the 2010PS, the next module is the 2010DB-00, followed by twelve 2016AVIM-4 modules, inputs 257-448, and four 2024VOM-1 modules, outputs 33-48.

Smaller matrices such as those ordered with future expansion in mind, may have fewer modules installed.

#### **IDENTIFY THESE MODULES CAREFULLY BEFORE PROCEEDING.**

**Data Interconnect:** See LEVEL 3 - 192 X 48, Three Bay System and connect all bays in a similar manner.

**Video Interconnections:** The 16 video outputs from bay 1, bay 3, and bay 5 located on the rear panel of the 2010DB-11, -12, and -13 respectively, are grouped by fours and identified by the icon. 

Each 2024VOM-1 is similarly grouped with three sections of four BNCs, with identifying icons. A fourth section of four BNCs is used for video output connections. The left most 2024VOM-1 module is assigned to outputs 1-4, the next for outputs 5-8, etc.

Using high grade RG-59U video cables, connect the top-most BNC from bay 1 on the 2010DB-11 panel, numbered 1, to the 2024VOM-1 in bay 2, for output 1, matching icon to icon . Continue in this manner until connections 1-4 of the 2010DB-11 panel are connected to inputs 1-4 of the first 2024VOM-1. Proceed to the next group of four BNCs on the 2010DB-11 of the first bay and connect these four to the second 2024VOM-1 in the second bay for outputs 5-8. Continue in this manner until all 16 connections of the 2010DB-11 panel are connected to the 2024VOM-1s for outputs 1-16.

Connect the top-most BNC from bay 3 on the 2010DB-12 panel, numbered 17, to the 2024VOM-1 in bay 4, for output 17, matching icon to icon.  Continue in this manner until connections 17-20 of the 2010DB-12 panel are connected to inputs 17-20 of the first 2024VOM-1 of the fourth bay. Proceed to the next group of four BNCs on the 2010DB-12 panel of the third bay and connect these four to the second 2024VOM-1 of the fourth bay for outputs 21-24. Continue in this manner until all 16 connections of the 2010DB-12 panel are connected to the 2024VOM-1s in the fourth bay for outputs 17-32.

Connect the top-most BNC from bay 5 on the 2010DB-13 panel, numbered 33, to the 2024VOM-1 in bay 6, for output 33, matching icon to icon.  Continue in this manner until connections 33-36 of the 2010DB-13 panel are connected to inputs 33-36 of the first 2024VOM-1 of the sixth bay. Proceed to the next group of four BNCs on the 2010DB-13 of the fifth bay and connect these four to the second 2024VOM-1 of the sixth bay for outputs 37-40. Continue in this manner until all 16 connections of the 2010DB-13 panel are connected to the 2024VOM-1s in the sixth bay for outputs 33-48. See Appendix Figure A18, Video Interconnections.

If there are less than twelve 2024VOM-1s in the system, the remaining BNCs on the 2010DB-XX do not require any connection.

**Video Input Connections:** See LEVEL 3 - 192 X 48, Three Bay System and connect in a similar manner.

**Video Output Connections:** See LEVEL 3 - 192 X 48, Three Bay System.

In the Appendix, see Figure A14, 448 X 48, Six Bay System.

**LEVEL 3 - 512 X 48, Seven Bay System**

A seven bay, Level 3 system allows a maximum of 512 video inputs switched to a maximum 48 video outputs. Bays one through six consists of 256 video inputs, and bay seven consists of 48 video outputs.

From the rear of bay one, the modules are installed at the factory in the following manner; the far right module is the 2010PS, the next module is the 2010DB-11 with 16 BNCs for connection to the 2024VOM-1 modules in bay seven, followed by sixteen 2016AVIM-2 modules, inputs 1-256.

From the rear of bay two, the modules are installed at the factory in the following manner; the far right module is the 2010PS, the next module is the 2010DB-21 with 16 BNCs for connection to the 2024VOM-1 modules in bay seven, followed by sixteen 2016AVIM-2 modules, inputs 257-512.

From the rear of bay three, the modules are installed at the factory in the following manner; the far right module is the 2010PS, the next module is the 2010DB-12 with 16 BNCs for connection to the 2024VOM-1 modules in bay seven, followed by sixteen 2016AVIM-3 modules, inputs 1-256.

From the rear of bay four, the modules are installed at the factory in the following manner; the far right module is the 2010PS, the next module is the 2010DB-22 with 16 BNCs for connection to the 2024VOM-1 modules in bay seven, followed by sixteen 2016AVIM-3 modules, inputs 257-512.

From the rear of bay five, the modules are installed at the factory in the following manner; the far right module is the 2010PS, the next module is the 2010DB-13 with 16 BNCs for connection to the 2024VOM-1 modules in bay seven, followed by sixteen 2016AVIM-4 modules, inputs 1-256.



From the rear of bay six, the modules are installed at the factory in the following manner; the far right module is the 2010PS, the next module is the 2010DB-23 with 16 BNCs for connection to the 2024VOM-1 modules in bay seven, followed by sixteen 2016AVIM-4 modules, inputs 257-512.

From the rear of bay seven, the modules are installed at the factory in the following manner; the far right module is the 2010PS, the next module is the 2010DB-00, followed by twelve 2024VOM-1 modules, installed left to right, for outputs 1-48.

Smaller matrices such as those ordered with future expansion in mind, may have fewer modules installed.

**IDENTIFY THESE MODULES CAREFULLY  
BEFORE PROCEEDING.**

**Data Interconnect:** See LEVEL 3 - 192 X 48, Three Bay System and connect all bays in a similar manner.

**Video Interconnections:** The 16 video outputs from bay 1 through 6, located on the rear panel of the 2010DB-11, -12, -13,  and -21, -22, and -23  respectively, are grouped by fours and are identified by their icons.

Each 2024VOM-1 is similarly grouped with three sections of four BNCs, with identifying icons. The left-most 2024VOM-1 module is assigned to outputs 1 - 4, the next for outputs 5 - 8, etc. See Figure 21, page 9, Video Output Module.

Using high grade RG-59U video cables, connect the topmost BNC from bay 1 on the 2010DB-11 panel, numbered 1, to the 2024VOM-1 in bay 7, for output 1, matching icon to icon . Continue in this manner until connections 1-4 of the 2010DB-11 panel are connected to inputs 1-4 of the first 2024VOM-1. Proceed to the next group of four BNCs on the 2010DB-11 of the first bay and connect these four to the second 2024VOM-1 for outputs 5-8. Continue in this manner until all 16 connections of the 2010DB-11 panel are connected to the 2024VOM-1s for outputs 1-16.

Connect bay 3 in a similar manner to the 2024VOM-1s of bay 7 for video outputs 17 - 32, matching icon to icon. 

Connect bay 5 in a similar manner to the 2024VOM-1s of bay 7 for video outputs 33-48, matching icon to icon. 

Connect the topmost BNC from bay 2 on the 2010DB-21 panel, numbered 1, to the 2024VOM-1 in bay 7, for output 1, matching icon to icon.  Continue in this manner until connections 1-4 of the 2010DB-12 panel are connected to inputs 1-4 of the 2024VOM-1. Proceed to the next group of four BNCs on the 2010DB-12 and connect these four to the second 2024VOM-1 for outputs 5-8. Continue in this manner until all 16 connections of the 2010DB-12 panel are connected to the 2024VOM-1s for outputs 1-16.

Connect bay 4 in a similar manner to the 2024VOM-1s of bay 7 for video outputs 17-32, matching icon to icon. 

Connect bay 6 in a similar manner to the 2024VOM-1s of bay 7 for video outputs 33-48, matching icon to icon. 

See Appendix Figure A18, Video Interconnections, for illustration of these connections.

If there are less than twelve 2024VOM-1s in the system the remaining BNCs on the 2010DB-XX do not require any connection.

**Video Input Connections:** See LEVEL 3 - 192 X 48, Three Bay System and connect in a similar manner.

**Video Output Connections:** All video outputs are located in bay 7. See LEVEL 3 - 192 X 48, Three Bay System and connect in a similar manner.

## SYSTEM CONFIGURATIONS

---

### LEVEL 3- 704 X 48, Nine Bay System

A nine bay, Level 3 system allows a maximum of 704 video inputs switched to a maximum 48 video outputs. Bays one, two, four, five, seven, and eight consists of 256 video inputs each. Bay three consists of 192 video inputs with the first group of 16 video outputs. Bay six consists of 192 video inputs with the second group 16 video outputs. Bay nine consists of 192 video inputs with the third group 16 video outputs.

From the rear of bay one, the modules are installed at the factory in the following manner; the far right module is the 2010PS, the next module is the 2010DB-11 with 16 BNCs for connection to the 2024VOM-1 modules in bay three, followed by sixteen 2016AVIM-2 modules, inputs 1-256.

From the rear of bay two, the modules are installed at the factory in the following manner; the far right module is the 2010PS, the next module is the 2010DB-21 with 16 BNCs for connection to the 2024VOM-1 modules in bay three, followed by sixteen 2016AVIM-2 modules, inputs 257-512.

From the rear of bay three, the modules are installed at the factory in the following manner; the far right module is the 2010PS, the next module is the 2010DB-00, followed by twelve 2016AVIM-2 modules, inputs 513-704, and four 2024VOM-1 modules, outputs 1-16.

From the rear of bay four, the modules are installed at the factory in the following manner; the far right module is the 2010PS, the next module is the 2010DB-12 with 16 BNCs for connection to the 2024VOM-1 modules in bay six, followed by sixteen 2016AVIM-3 modules, inputs 1-256.

From the rear of bay five, the modules are installed at the factory in the following manner; the far right module is the 2010PS, the next module is the 2010DB-22 with 16 BNCs for connection to the 2024VOM-1 modules in bay six, followed by sixteen 2016AVIM-3 modules, inputs 257-512.

From the rear of bay six, the modules are installed at the factory in the following manner; the far right module is the 2010PS, the next module is the 2010DB-00, followed by twelve 2016AVIM-3 modules, inputs 513-704, and four 2024VOM-1 modules, outputs 17-32.

From the rear of bay seven, the modules are installed at the factory in the following manner; the far right module is the 2010PS, the next module is the 2010DB-13 with 16 BNCs for connection to the 2024VOM-1 modules in bay nine, followed by sixteen 2016AVIM-4 modules, inputs 1-256.



From the rear of bay eight, the modules are installed at the factory in the following manner; the far right module is the 2010PS, the next module is the 2010DB-23 with 16 BNCs for connection to the 2024VOM-1 modules in bay nine, followed by sixteen 2016AVIM-4 modules, inputs 257-512.

From the rear of bay nine, the modules are installed at the factory in the following manner; the far right module is the 2010PS, the next module is the 2010DB-00, followed by twelve 2016AVIM-4 modules, inputs 513-704, and four 2024VOM-1 modules, outputs 33-48.

Smaller matrices such as those ordered with future expansion in mind, may have fewer modules installed.

#### IDENTIFY THESE MODULES CAREFULLY BEFORE PROCEEDING.

**Data Interconnect:** See LEVEL 3 - 192 X 48, three bay system and connect all bays in a similar manner.

**Video Interconnections:** The 16 video outputs from bays 1, 2, 4, 5, 7 and 8 located on the rear panel of the 2010DB-11, -12, -13  and -21, -22, and -23  respectively, are grouped by fours and identified by their icon(s).

Each 2024VOM-1 is similarly grouped with three sections of four BNCs, with identifying icons. A fourth section of four BNCs is used for video output connections. The left-most 2024VOM-1 module is assigned to outputs 1 - 4, the next for outputs 5 - 8, etc. See Figure 21, Video Output Module, page 9.

Using high grade RG-59U video cables, connect the topmost BNC from bay 1 on the 2010DB-11 panel, numbered 1, to the 2024VOM-1 in bay 3, for output 1, matching icon to icon . Continue in this manner until connections 1-4 of the 2010DB-11 panel are connected to inputs 1-4 of the first 2024VOM-1. Proceed to the next group of four BNCs on the 2010DB-11 of the first bay and connect these four to the second 2024VOM-1 for outputs 5-8. Continue in this manner until all 16 connections of the 2010DB-11 panel are connected to the 2024VOM-1s for outputs 1 - 16.

Connect bay 4 in a similar manner to the 2024VOM-1s of bay 6 for video outputs 17 - 32, matching icon to icon. 

Connect bay 7 in a similar manner to the 2024VOM-1s of bay 9 for video outputs 33 - 48, matching icon to icon. 

Connect the topmost BNC from bay 2 on the 2010DB-21 panel, numbered 1, to the 2024VOM-1 in bay 3, for output 1, matching icon to icon. 

Continue in this manner until connections 1-4 of the 2010DB-12 panel are connected to inputs 1-4 of the 2024VOM-1 of bay 3. Proceed to the next group of four BNCs on the 2010DB-12 and connect these four to the second 2024VOM-1 for outputs 5-8. Continue in this manner until all 16 connections of the 2010DB-21 panel are connected to the 2024VOM-1's for outputs 1-16.

Connect bay 5 in a similar manner to the 2024VOM-1 of bay 6 for video outputs 17 - 32, matching icon to icon. 

Connect bay 8 in a similar manner to the 2024VOM-1s of bay 9 for video outputs 33 - 48, matching icon to icon. 

See Appendix Figure A18, Video Interconnections, for illustration of these connections.

If there are less than twelve 2024VOM-1s in the system the remaining BNCs on the 2010DB-XX do not require any connection.

**Video Input Connections:** See LEVEL 3 - 192 X 48, Three Bay System and connect in a similar manner.

**Video Output Connections:** See LEVEL 3 - 192 X 48, Three Bay System and connect in a similar manner.

In the Appendix, see Figure A15, 704 X 48, Nine Bay System.

## SYSTEM CONFIGURATIONS

### LEVEL 3 - 768 X 48, Ten Bay System

A seven bay, Level 3 system allows a maximum of 768 video inputs switched to a maximum 48 video outputs. Bays one through nine consists of 256 video inputs, and bay ten consists of 48 video outputs.

From the rear of bay one, the modules are installed at the factory in the following manner; the far right module is the 2010PS, the next module is the 2010DB-11 with 16 BNCs for connection to the 2024VOM-1 modules in bay ten, followed by sixteen 2016AVIM-2 modules, inputs 1-256.

From the rear of bay two, the modules are installed at the factory in the following manner; the far right module is the 2010PS, the next module is the 2010DB-21 with 16 BNCs for connection to the 2024VOM-1 modules in bay ten, followed by sixteen 2016AVIM-2 modules, inputs 257-512.

From the rear of bay three, the modules are installed at the factory in the following manner; the far right module is the 2010PS, the next module is the 2010DB-31 with 16 BNCs for connection to the 2024VOM-1 modules in bay ten, followed by sixteen 2016AVIM-2 modules, inputs 513-768.

From the rear of bay four, the modules are installed at the factory in the following manner; the far right module is the 2010PS, the next module is the 2010DB-12 with 16 BNCs for connection to the 2024VOM-1 modules in bay ten, followed by sixteen 2016AVIM-3 modules, inputs 1-256.

From the rear of bay five, the modules are installed at the factory in the following manner; the far right module is the 2010PS, the next module is the 2010DB-22 with 16 BNCs for connection to the 2024VOM-1 modules in bay ten, followed by sixteen 2016AVIM-3 modules, inputs 257-512.

From the rear of bay six, the modules are installed at the factory in the following manner; the far right module is the 2010PS, the next module is the 2010DB-32 with 16 BNCs for connection to the 2024VOM-1 modules in bay ten, followed by sixteen 2016AVIM-3 modules, inputs 513-768.

From the rear of bay seven, the modules are installed at the factory in the following manner; the far right module is the 2010PS, the next module is the 2010DB-13 with 16 BNCs for connection to the 2024VOM-1 modules in bay ten, followed by sixteen 2016AVIM-4 modules, inputs 1-256.

From the rear of bay eight, the modules are installed at the factory in the following manner; the far right module is the 2010PS, the next module is the 2010DB-23 with 16 BNCs for connection to the 2024VOM-1 modules in bay ten, followed by sixteen 2016AVIM-4 modules, inputs 257-512.



From the rear of bay nine, the modules are installed at the factory in the following manner; the far right module is the 2010PS, the next module is the 2010DB-33 with 16 BNCs for connection to the 2024VOM-1 modules in bay ten, followed by sixteen 2016AVIM-4 modules, inputs 513-768.

From the rear of bay ten, the modules are installed at the factory in the following manner; the far right module is the 2010PS, the next module is the 2010DB-00, followed by twelve 2024VOM-1 modules, installed left to right, for outputs 1-48.

Smaller matrices such as those ordered with future expansion in mind, may have fewer modules installed.

### IDENTIFY THESE MODULES CAREFULLY BEFORE PROCEEDING.

**Data Interconnect:** See LEVEL 3 - 192 X 48, Three Bay System and connect all bays in a similar manner.

**Video Interconnections:** The 16 video outputs from bay 1, through 9 located on the rear panel of the 2010DB-11, -12, -13,  , -21, -22, -23,  , and on rear panels -31, -32, and -33  respectively.

They are grouped by fours and identified by their icons.

Each 2024VOM-1 is similarly grouped with three sections of four BNCs, with identifying icons. A fourth section of four BNCs is used for video output connections. The left-most 2024VOM-1 module is assigned to outputs 1 - 4, the next for outputs 5 - 8, etc. See Figure 21, page 9.

Using high grade RG-59U video cables, connect the topmost BNC from bay 1 on the 2010DB-11 panel, numbered 1, to the 2024VOM-1 in bay 10, for output 1, matching icon to icon. 

Continue in this manner until connections 1-4 of the 2010DB-11 panel are connected to inputs 1-4 of the first 2024VOM-1. Proceed to the next group of four BNCs on the 2010DB-11 of the first bay and connect these four to the second 2024VOM-1 of bay 10 for outputs 5-8. Continue in this manner until all 16 connections of the 2010DB-11 panel are connected to the 2024VOM-1s for outputs 1-16.

Connect bay 4 in a similar manner to the 2024VOM-1s of bay 10 for video outputs 17-32, matching icon to icon. 

Connect bay 7 in a similar manner to the 2024VOM-1s of bay 10 for video outputs 33-48, matching icon to icon. 

Connect the top-most BNC from bay 2 on the 2010DB-21 panel, numbered 1, to the 2024VOM-1 in bay 10, for output 1, matching icon to icon. 



Continue in this manner until connections 1-4 of the 2010DB-12 panel are connected to inputs 1-4 of the 2024VOM-1. Proceed to the next group of four BNCs on the 2010DB-12 and connect these four to the second 2024VOM-1 for outputs 5-8. Continue in this manner until all 16 connections of the 2010DB-21 panel are connected to the 2024VOM-1 modules for outputs 1 - 16.

Connect bay 5 in a similar manner to the 2024VOM-1s of bay 10 for video outputs 17-32, matching icon to icon. 

Connect bay 8 in a similar manner to the 2024VOM-1s of bay 10 for video outputs 33-48, matching icon to icon.

Connect the topmost BNC from bay 3 on the 2010DB-31 panel, numbered 1, to the 2024VOM-1 in bay 10, for output 1, matching icon to icon. 

Continue in this manner until connections 1-4 of the 2010DB-31 panel are connected to inputs 1-4 of the 2024VOM-1. Proceed to the next group of four BNCs on the 2010DB-12 and connect these four to the second 2024VOM-1 of bay 10 for outputs 5-8. Continue in this manner until all 16 connections of the 2010DB-31 panel are connected to the 2024VOM-1s for outputs 1-16.

Connect bay 6 in a similar manner to the 2024VOM-1s of bay 10 for video outputs 17-32, matching icon to icon. 

Connect bay 9 in a similar manner to the 2024VOM-1s of bay 10 for video outputs 33-48, matching icon to icon. 

See Appendix Figure A18, Video Interconnections, for illustration of these connections.

If there are less than twelve 2024VOM-1s in the system the remaining BNCs on the 2010DB-XX do not require any connection.

**Video Input Connections:** See LEVEL 3 - 192 X 48, Three Bay System and connect in a similar manner.

**Video Output Connections:** All video outputs are located in bay 4. See LEVEL 3 - 192 X 48, Three Bay System and connect in a similar manner.

In the Appendix, see Figure A16, 768 X 48, Ten Bay System.

## SYSTEM CONFIGURATIONS

### LEVEL 3 - 960 X 48, Twelve Bay System

The twelve bay Level 3 system allows a maximum of 960 video inputs switched to a maximum 48 video outputs. Bays one, two, three, five, six, seven, nine, ten and eleven consists of 256 video inputs each, bay four consists of 192 video inputs with the first group 16 video outputs, bay eight consists of 192 video inputs with the second group 16 video outputs, bay twelve consists of 192 video inputs with the third group 16 video outputs.

From the rear of bay one, the modules are installed at the factory in the following manner; the far right module is the 2010PS, the next module is the 2010DB-11 with 16 BNCs for connection to the 2024VOM-1 modules in bay four, followed by sixteen 2016AVIM-2 modules, inputs 1-256.

From the rear of bay two, the modules are installed at the factory in the following manner; the far right module is the 2010PS, the next module is the 2010DB-21 with 16 BNCs for connection to the 2024VOM-1 modules in bay four, followed by sixteen 2016AVIM-2 modules, inputs 257-512.

From the rear of bay three, the modules are installed at the factory in the following manner; the far right module is the 2010PS, the next module is the 2010DB-31 with 16 BNCs for connection to the 2024VOM-1 modules in bay four, followed by sixteen 2016AVIM-2 modules, inputs 513-768.

From the rear of bay four, the modules are installed at the factory in the following manner; the far right module is the 2010PS, the next module is the 2010DB-00, followed by twelve 2016AVIM-2 modules and four 2024VOM-1 modules, inputs 769-960 and outputs 1-16.

From the rear of bay five, the modules are installed at the factory in the following manner; the far right module is the 2010PS, the next module is the 2010DB-12 with 16 BNCs for connection to the 2024VOM-1 modules in bay eight, followed by sixteen 2016AVIM-3 modules, inputs 1-256.

From the rear of bay six, the modules are installed at the factory in the following manner; the far right module is the 2010PS, the next module is the 2010DB-22 with 16 BNCs for connection to the 2024VOM-1 modules in bay eight, followed by sixteen 2016AVIM-3 modules, inputs 257-512.

From the rear of bay seven, the modules are installed at the factory in the following manner; the far right module is the 2010PS, the next module is the 2010DB-32 with 16 BNCs for connection to the 2024VOM-1 modules in bay eight, followed by sixteen 2016AVIM-3 modules, inputs 513-768.

From the rear of bay eight, the modules are installed at the factory in the following manner; the far right module is the 2010PS, the next module is the 2010DB-00, followed by

twelve 2016AVIM-3 modules and four 2024VOM-1 modules, inputs 769-960 and outputs 17-32.

From the rear of bay nine, the modules are installed at the factory in the following manner; the far right module is the 2010PS, the next module is the 2010DB-13 with 16 BNCs for connection to the 2024VOM-1 modules in bay twelve, followed by sixteen 2016AVIM-4 modules, inputs 1-256.

From the rear of bay ten, the modules are installed at the factory in the following manner; the far right module is the 2010PS, the next module is the 2010DB-23 with 16 BNCs for connection to the 2024VOM-1 modules in bay twelve, followed by sixteen 2016AVIM-4 modules, inputs 257-512.



From the rear of bay eleven, the modules are installed at the factory in the following manner; the far right module is the 2010PS, the next module is the 2010DB-33 with 16 BNCs for connection to the 2024VOM-1 modules in bay twelve, followed by sixteen 2016AVIM-4 modules, inputs 513-768.

From the rear of bay twelve, the modules are installed at the factory in the following manner; the far right module is the 2010PS, the next module is the 2010DB-00, followed by twelve 2016AVIM-4 modules and four 2024VOM-1 modules, inputs 769-960 and outputs 33-48.

Smaller matrices such as those ordered with future expansion in mind, may have fewer modules installed.

#### **IDENTIFY THESE MODULES CAREFULLY BEFORE PROCEEDING.**

**Data Interconnect:** See LEVEL 3 - 192 X 48, three bay system and connect all bays in a similar manner.

**Video Interconnections:** The 16 video outputs from bays 1, 2, 3, 5, 6, 7, 9, 10 and 11 located on the rear panel of the 2010DB-11, -12, -13  , 2010DB-21, -22, -23  , and 2010DB-31, -32, -33  respectively.

They are grouped by fours and identified by their icons.

Each 2024VOM-1 is similarly grouped with three sections of four BNCs, with identifying icons. A fourth section of four BNCs is used for video output connections. The left-most 2024VOM-1 module is assigned to outputs 1 - 4, the next for outputs 5 - 8, etc. See Figure 21, Video Output Module, page 9.

Using high grade RG-59U video cables, connect the top-most BNC from bay 1 on the 2010DB-11 panel, numbered 1, to the 2024VOM-1 in bay 4, for output 1, matching icon to icon. 

Continue in this manner until connections 1-4 of the 2010DB-11 panel are connected to inputs 1-4 of the first 2024VOM-1 of bay 4. Proceed to the next group of four BNCs on the 2010DB-11 of the first bay and connect these four to the second 2024VOM-1 for outputs 5-8. Continue in this manner until all 16 connections of the 2010DB-11 panel are connected to the 2024VOM-1 modules.

Connect bay 5 in a similar manner to the 2024VOM-1s of bay 8 for video outputs 17-32, matching icon to icon. 

Connect bay 9 in a similar manner to the 2024VOM-1s of bay 12 for video outputs 33-48, matching icon to icon. 

Connect the topmost BNC from bay 2 on the 2010DB-21 panel, numbered 1, to the 2024VOM-1 in bay 4, for output 1, matching icon to icon. 

Continue in this manner until connections 1-4 of the 2010DB-21 panel are connected to inputs 1-4 of the 2024VOM-1 of bay 4. Proceed to the next group of four BNCs on the 2010DB-21 and connect these four to the second 2024VOM-1 for outputs 5-8. Continue in this manner until all 16 connections of the 2010DB-21 panel are connected to the 2024VOM-1s for outputs 1-16.

Connect bay 6 in a similar manner to the 2024VOM-1s of bay 8 for video outputs 17-32, matching icon to icon. 

Connect bay 10 in a similar manner to the 2024VOM-1s of bay 12 for video outputs 33-48, matching icon to icon. 

Connect the top-most BNC from bay 3 on the 2010DB-31 panel, numbered 1, to the 2024VOM-1 in bay 4, for output 1, matching icon to icon. 

Continue in this manner until connections 1-4 of the 2010DB-31 panel are connected to inputs 1-4 of the 2024VOM-1. Proceed to the next group of four BNCs on the 2010DB-31 and connect these four to the second 2024VOM-1 for outputs 5-8. Continue in this manner until all 16 connections of the 2010DB-31 panel are connected to the 2024VOM-1s for outputs 1-16.

Connect bay 7 in a similar manner to the 2024VOM-1s of bay 8 for video outputs 17-32, matching icon to icon. 

Connect bay 11 in a similar manner to the 2024VOM-1s of bay 12 for video outputs 33-48, matching icon to icon. 

See Appendix Figure A18, Video Interconnections, for illustration of these connections.

If there are less than eight 2024VOM-1s in the system the remaining BNCs on the 2010DB-XX do not require any connection.

**Video Input Connections:** See LEVEL 3 - 192 X 48, Three Bay System and connect in a similar manner.

**Video Output Connections:** See LEVEL 3 - 192 X 48, Three Bay System and connect in a similar manner.

## SYSTEM CONFIGURATIONS

---

### LEVEL 3 - 1024 X 48, Fourteen Bay System

A fourteen bay, Level 3 System allows a maximum of 1024 video inputs switched to a maximum 48 video outputs. Bays one through twelve consists of 256 video inputs, and bay thirteen consists of the first 32 video outputs and bay 14 consists of the second group of 16 video outputs.

From the rear of bay one, the modules are installed at the factory in the following manner; the far right module is the 2010PS, the next module is the 2010DB-11 with 16 BNCs for connection to the 2024VOM-2 modules in bay thirteen, followed by sixteen 2016AVIM-2 modules, inputs 1-256.

From the rear of bay two, the modules are installed at the factory in the following manner; the far right module is the 2010PS, the next module is the 2010DB-21 with 16 BNCs for connection to the 2024VOM-2 modules in bay thirteen, followed by sixteen 2016AVIM-2 modules, inputs 257-512.

From the rear of bay three, the modules are installed at the factory in the following manner; the far right module is the 2010PS, the next module is the 2010DB-31 with 16 BNCs for connection to the 2024VOM-2 modules in bay thirteen, followed by sixteen 2016AVIM-2 modules, inputs 513-768.

From the rear of bay four, the modules are installed at the factory in the following manner; the far right module is the 2010PS, the next module is the 2010DB-41 with 16 BNCs for connection to the 2024VOM-2 modules in bay thirteen, followed by sixteen 2016AVIM-2 modules, inputs 769-1024.

From the rear of bay five, the modules are installed at the factory in the following manner; the far right module is the 2010PS, the next module is the 2010DB-12 with 16 BNCs for connection to the 2024VOM-2 modules in bay thirteen, followed by sixteen 2016AVIM-3 modules, inputs 1-256.

From the rear of bay six, the modules are installed at the factory in the following manner; the far right module is the 2010PS, the next module is the 2010DB-22 with 16 BNCs for connection to the 2024VOM-2 modules in bay thirteen, followed by sixteen 2016AVIM-3 modules, inputs 257-512.

From the rear of bay seven, the modules are installed at the factory in the following manner; the far right module is the 2010PS, the next module is the 2010DB-32 with 16 BNCs for connection to the 2024VOM-2 modules in bay thirteen, followed by sixteen 2016AVIM-3 modules, inputs 513-768.

From the rear of bay eight, the modules are installed at the factory in the following manner; the far right module is the 2010PS, the next module is the 2010DB-42 with 16 BNCs for connection to the 2024VOM-2 modules in bay thirteen, followed by sixteen 2016AVIM-3 modules, inputs 769-1024.

From the rear of bay nine, the modules are installed at the factory in the following manner; the far right module is the 2010PS, the next module is the 2010DB-13 with 16 BNCs for connection to the 2024VOM-2 modules in bay fourteen, followed by sixteen 2016AVIM-4 modules, inputs 1-256.

From the rear of bay ten, the modules are installed at the factory in the following manner; the far right module is the 2010PS, the next module is the 2010DB-23 with 16 BNCs for connection to the 2024VOM-2 modules, in bay fourteen followed by sixteen 2016AVIM-4 modules, inputs 257-512.

From the rear of bay eleven, the modules are installed at the factory in the following manner; the far right module is the 2010PS the next module is the 2010DB-33 with 16 BNCs for connection to the 2024VOM-2 modules in bay fourteen, followed by sixteen 2016AVIM-4 modules, inputs 513-768.

From the rear of bay twelve, the modules are installed at the factory in the following manner; the far right module is the 2010PS, the next module is the 2010DB-43 with 16 BNCs for connection to the 2024VOM-2 modules in bay fourteen, followed by sixteen 2016AVIM-4 modules, inputs 769-1024.





From the rear of bay thirteen, the modules are installed at the factory in the following manner; the far right module is the 2010PS, the next module is the 2010DB-00, followed by eight 2024VOM-2 modules, installed left to right, outputs 1-32.

From the rear of bay fourteen, the modules are installed at the factory in the following manner; the far right module is the 2010PS, the next module is the 2010DB-00, followed by four 2024VOM-2 modules, installed left to right, outputs 33-48.

Smaller matrices such as those ordered with future expansion in mind, may have fewer modules installed.

#### IDENTIFY THESE MODULES CAREFULLY BEFORE PROCEEDING.

**Data Interconnect:** See LEVEL 3 - 192 X 48, three bay system and connect all bays in a similar manner.

**Video Interconnections:** The 16 video outputs from bay 1, through 12 located on the rear panel of the 2010DB-11, -12, -13 , 2010DB-21, -22, -23 , 2010DB-31, -32, -33 , and 2010DB-41, -42, and -43  respectively.

They are grouped by fours and identified by their icons.

Each 2024VOM-2 is similarly grouped with four sections of four BNCs, with identifying icons. A fifth group of four BNCs (lower left-hand corner) is used for video output. The left-most 2024VOM-2 module is assigned to outputs 1-4, the next for outputs 5-8, etc. See Figure 21, page 9.

Using high grade RG-59U video cables, connect the top most BNC from bay 1 on the 2010DB-11 panel, numbered 1, to the 2024VOM-2 in bay 13, for output 1, matching icon to icon. 

Continue in this manner until connections 1-4 of the 2010DB-11 panel are connected to inputs 1-4 of the first 2024VOM-2. Proceed to the next group of four BNCs on the 2010DB-11 and connect these to the second 2024VOM-2 for outputs 5-8.

Continue in this manner until all 16 connections of the 2010DB-11 panel are connected to the 2024VOM-2s for outputs 1-16.

Connect bay 5 in a similar manner to the 2024VOM-2s in bay 13 for video outputs 17-32, matching icon to icon. 

Connect the topmost BNC from bay 2 on the 2010DB-21 panel, numbered 1, to the 2024VOM-2 in bay 13, for output 1, matching icon to icon. 

Continue in this manner until connections 1-4 of the 2010DB-21 panel are connected to inputs 1-4 of the 2024VOM-2. Proceed to the next group of four BNCs on the 2010DB-21 and connect these to the second 2024VOM-2 for outputs 5-8. Continue in this manner until all 16 connections of the 2010DB-21 panel are connected to the 2024VOM-2s for outputs 1-16.

Connect bay 6 in a similar manner to the 2024VOM-2s in bay 13 for video outputs 17-32, matching icon to icon. 

Connect the topmost BNC from bay 3 on the 2010DB-31 panel, numbered 1, to the 2024VOM-2 in bay 13, for output 1, matching icon to icon. 

Continue in this manner until connections 1-4 of the 2010DB-31 panel are connected to inputs 1-4 of the 2024VOM-2. Proceed to the next group of four BNCs on the 2010DB-31 and connect these to the second 2024VOM-2 for outputs 5-8. Continue in this manner until all 16 connections of the 2010DB-31 panel are connected to the 2024VOM-2s for outputs 1-16.

Connect bay 7 in a similar manner to the 2024VOM-2s in bay 13 for video outputs 17-32, matching icon to icon. 

Connect the top-most BNC from bay 4 on the 2010DB-41 panel, numbered 1, to the 2024VOM-2 in bay 13, for output 1, matching icon to icon. 

Continue in this manner until connections 1-4 of the 2010DB-41 panel are connected to inputs 1-4 of the 2024VOM-2. Proceed to the next group of four BNCs on the 2010DB-41 and connect these to the second 2024VOM-2 for outputs 5-8. Continue in this manner until all 16 connections of the 2010DB-41 panel are connected to the 2024VOM-2s for outputs 1-16.

Connect bay 8 in a similar manner to the 2024VOM-2s in bay 13 for video outputs 17-32, matching icon to icon. 

Connect the topmost BNC from bay 9 on the 2010DB-13 panel, numbered 33, to the 2024VOM-2 in bay 14, for output 33, matching icon to icon. 

Continue in this manner until connections 33-36 of the 2010DB-13 panel are connected to inputs 33-36 of the 2024VOM-2 of bay 14. Proceed to the next group of four BNCs on the 2010DB-13 and connect these four to the second 2024VOM-2 for outputs 37 - 40. Continue in this manner until all 16 connections of the 2010DB-13 panel are connected to the 2024VOM-2s for outputs 33-48.

Connect bay 10 in a similar manner to the 2024VOM-2s of bay 14 for video outputs 17-32, matching icon to icon. 

Connect bay 11 in a similar manner to the 2024VOM-2s of bay 14 for video outputs 33-48, matching icon to icon. 

Connect bay 12 in a similar manner to the 2024VOM-2s for video outputs 33-48, matching icon to icon. 

See Appendix Figure A18, Video Interconnections, for illustration of these connections.

If there are less than twelve 2024VOM-2s in the system the remaining BNCs on the 2010DB-XX do not require any connection.

**Video Input Connections:** See LEVEL 3 - 256 X 48, three bay system and connect in a similar manner.

**Video Output Connections:** Each 2024VOM-2 has a rear panel with 20 BNCs. The right most module is assigned to outputs 1-4. The next module is for outputs 5-8, etc. (The modules are numbered 1-4, 5-8, etc.) Connect video outputs to any device that accepts standard video such as monitors or video recorders.

### **ADULP Loop Panel used with AD1024 Systems**

For information on the use of the AD Universal Loop Panel (ADULP) with AD1024 (or AD2050) switching systems, see *AD Universal Loop Panel Installation Instructions, Part Number 8000-0900-01*.







# Appendix



# 256 INPUTS X 16 OUTPUTS - With No TITLES

## Level 1 - 1 Bay

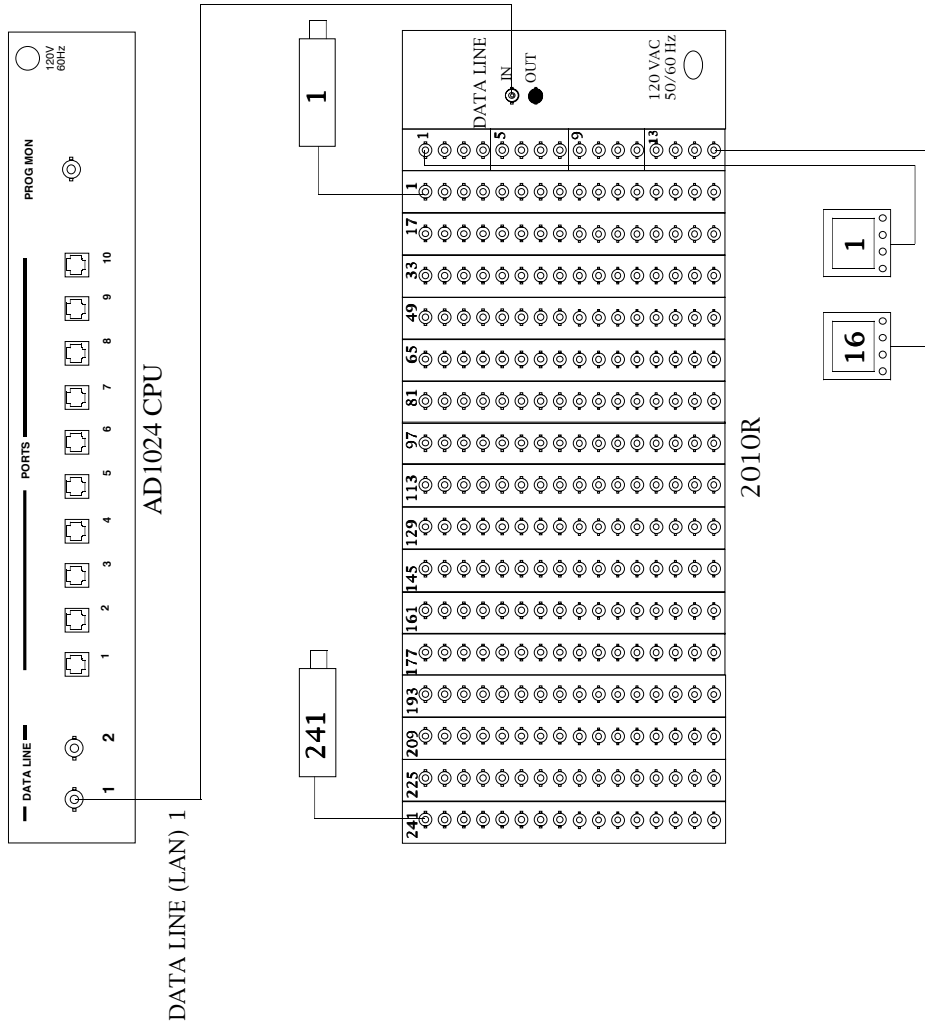

**192 INPUTS X 16 OUTPUTS**  
**Level 1 - 1 Bay**

DATA LINE (LAN) 1 FROM CPU

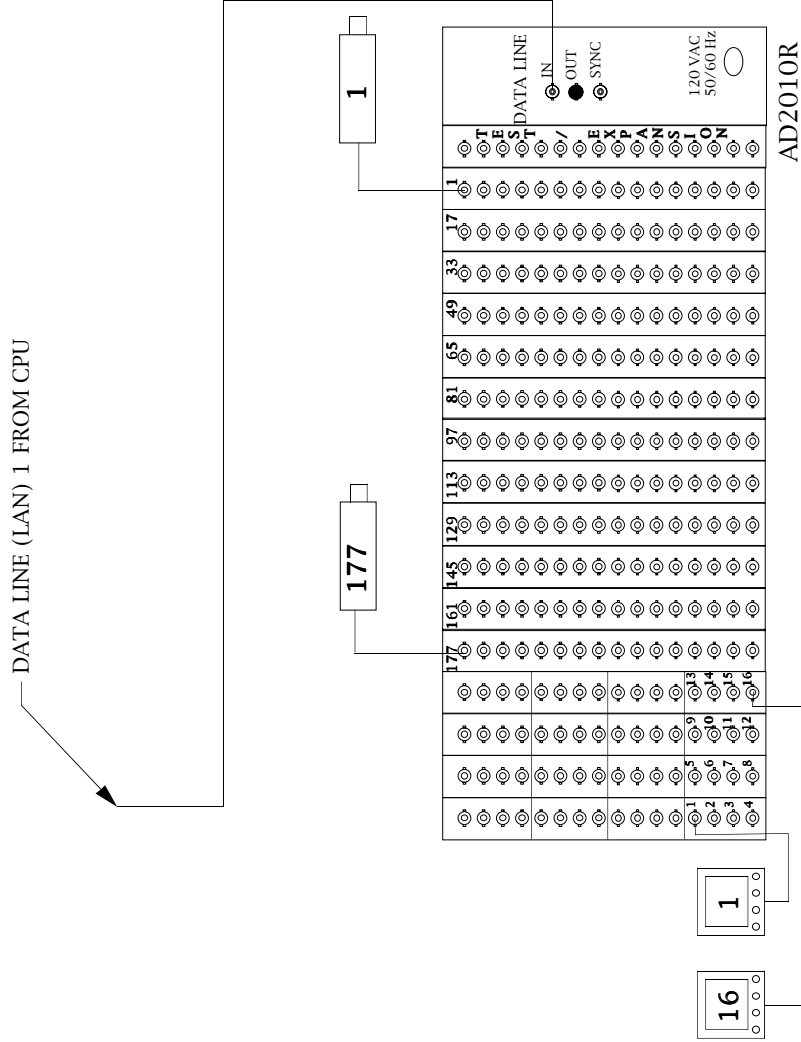

# 448 INPUTS X 16 OUTPUTS

## Level 1 - 2 Bays

DATA LINE (LAN) 1 FROM CPU

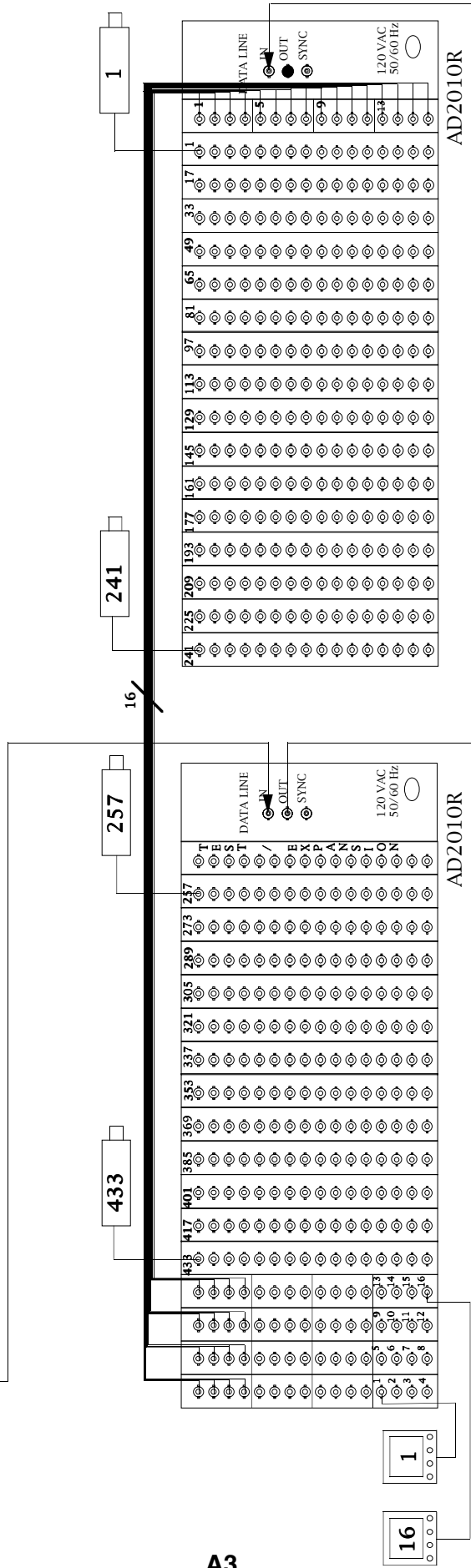

A3

# 704 INPUTS X 16 OUTPUTS (Page 1)

## Level 1 - 3 Bays

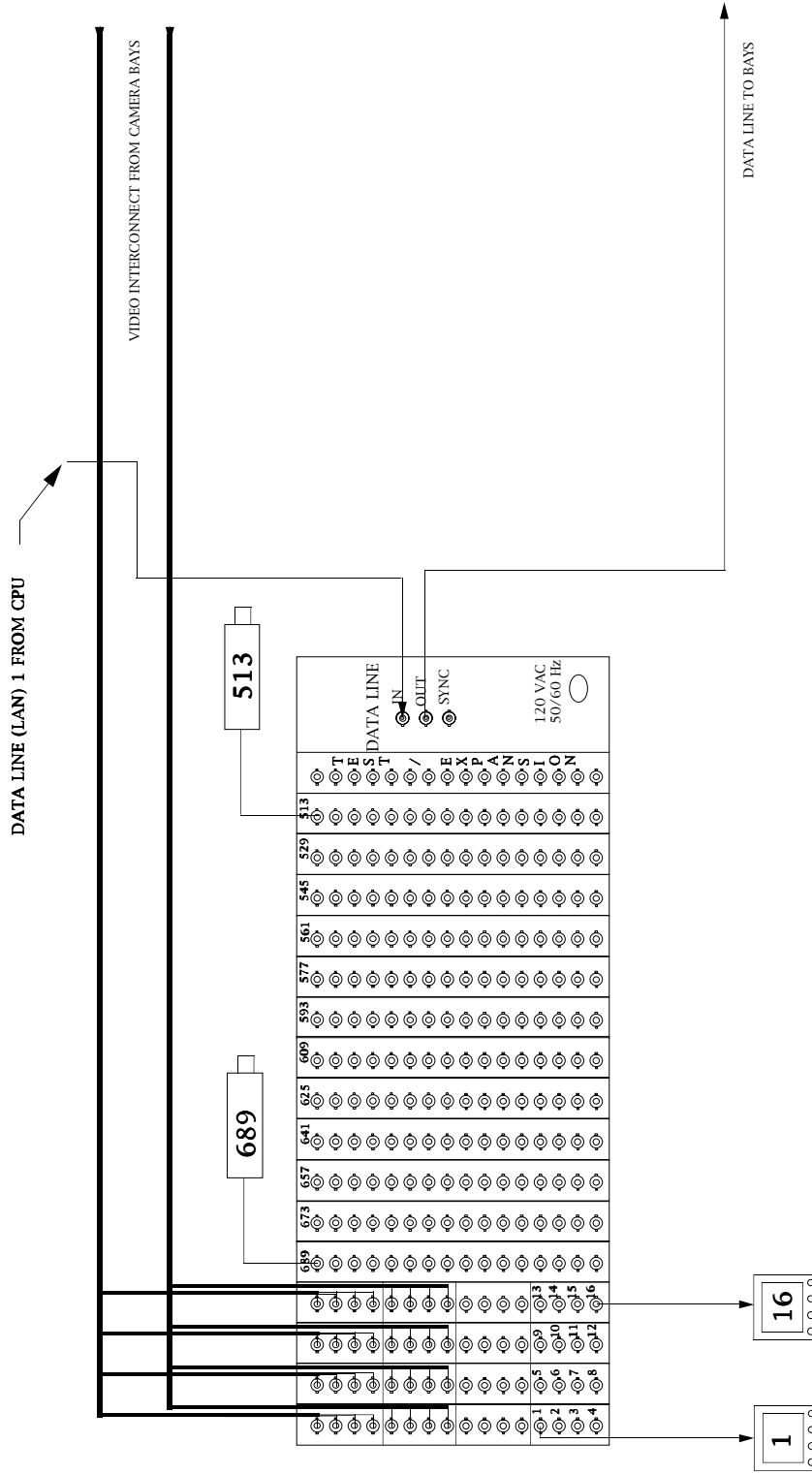

# 704 INPUTS X 16 OUTPUTS (Page 2)

## Level 1 - 3 Bays

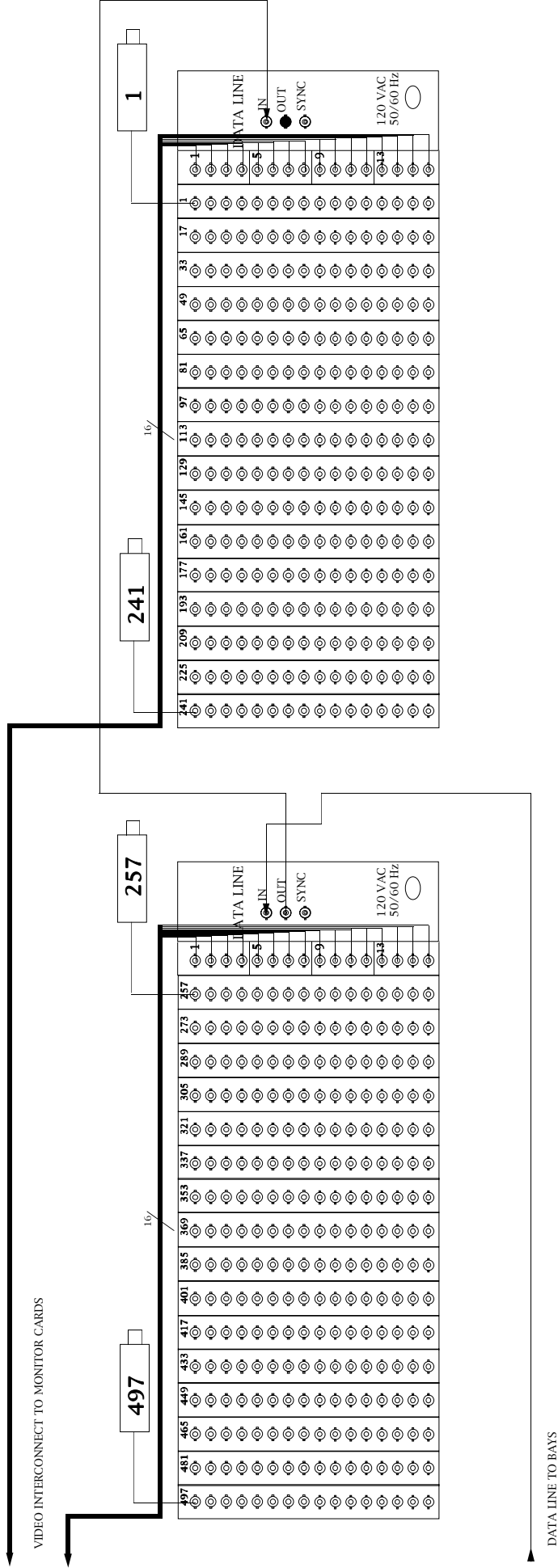

# 960 INPUTS X 16 OUTPUTS (Page 1)

## Level 1 - 4 Bays

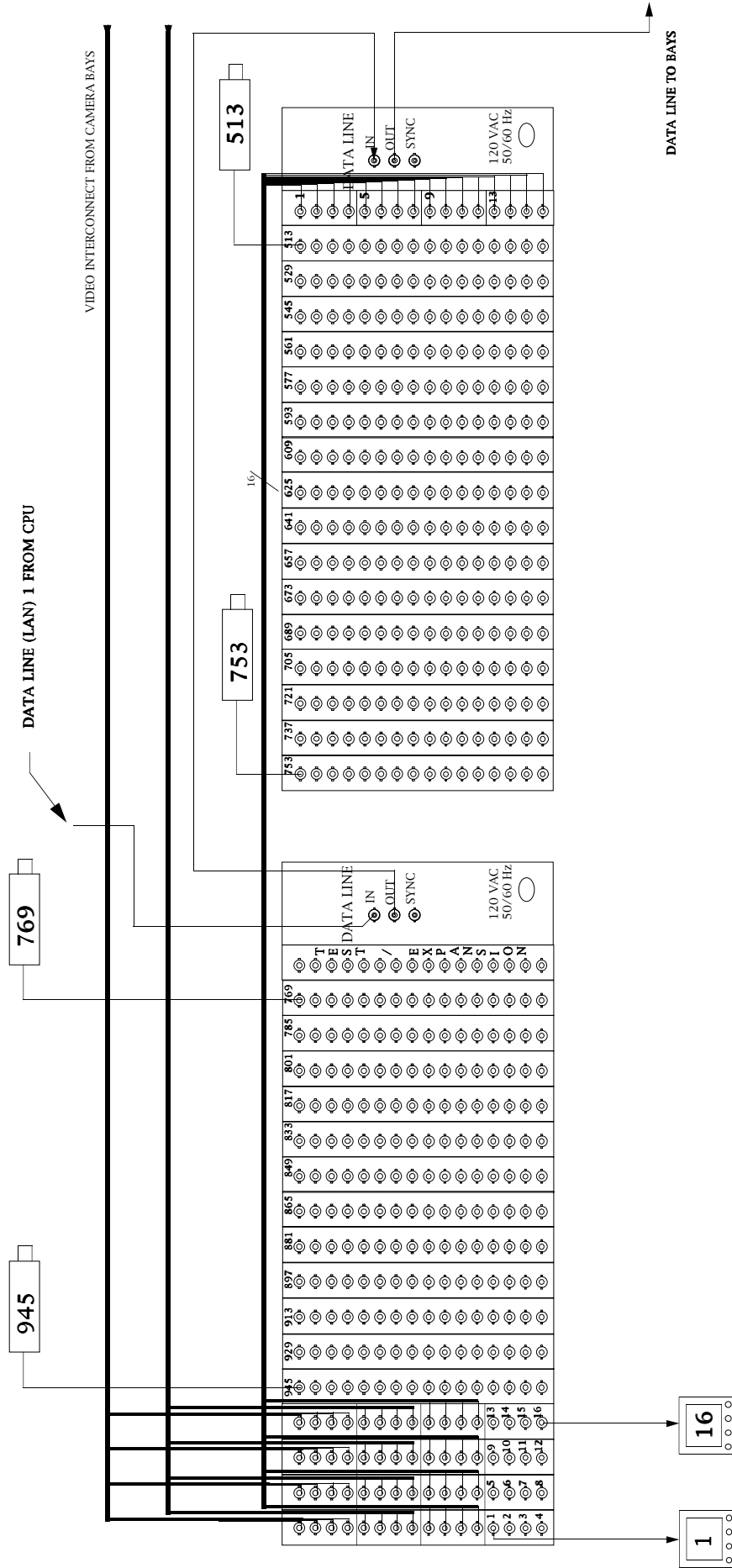



# 960 INPUTS X 16 OUTPUTS (Page 2)

## Level 1 - 4 Bays

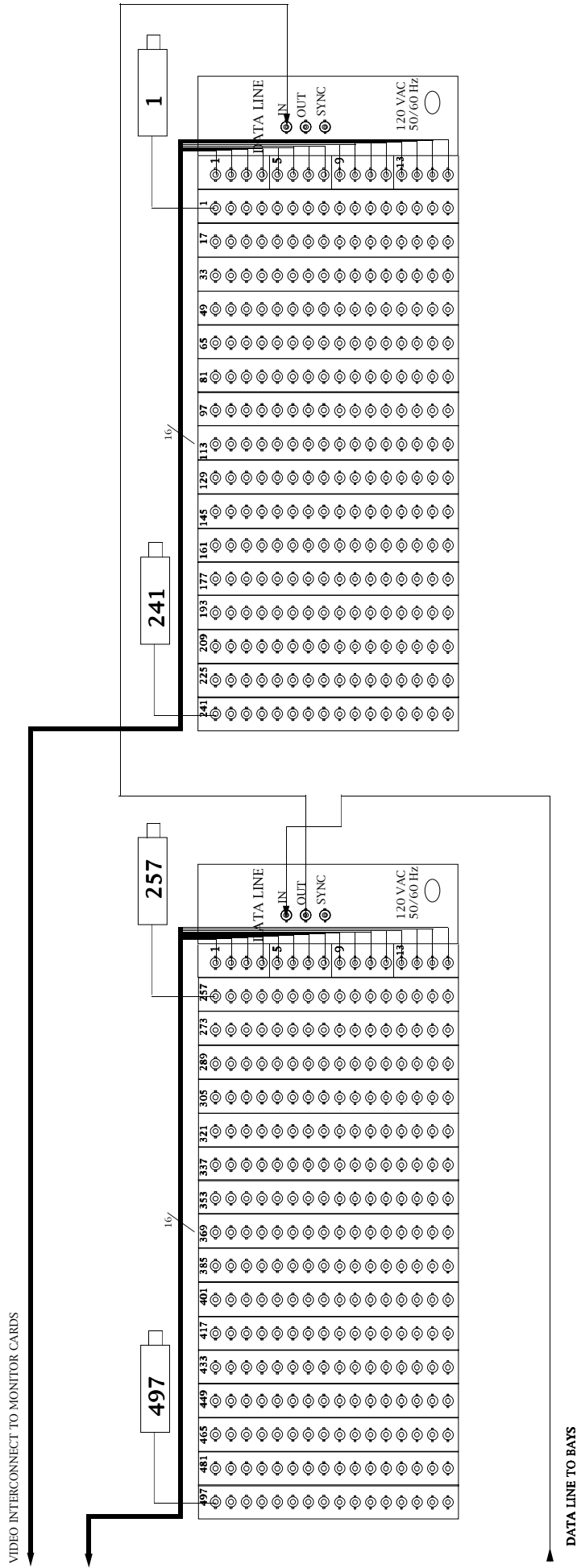

**64 INPUTS X 32 OUTPUTS**  
**Level 2 - 1 Bay**

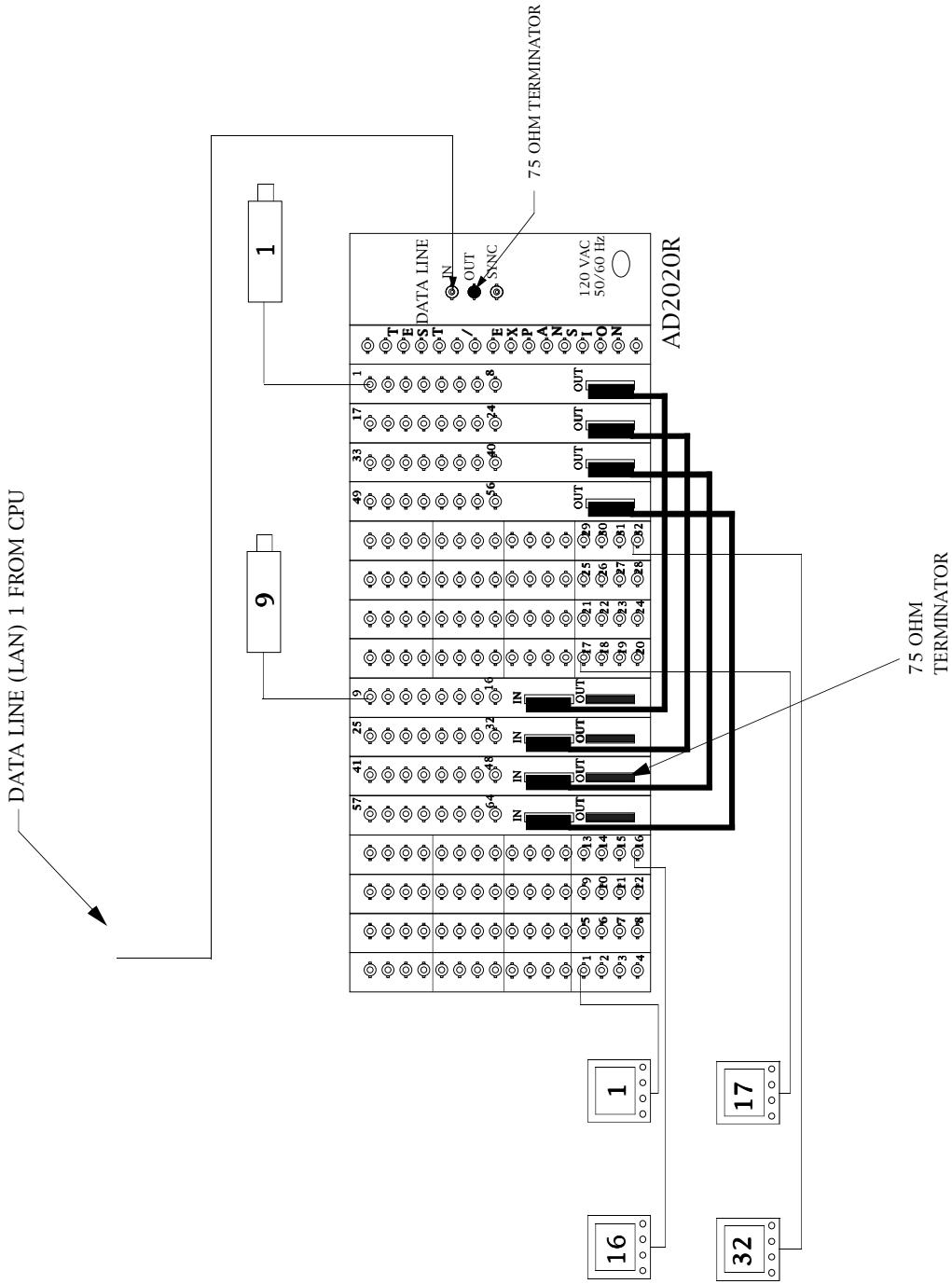

# 192 INPUTS X 32 OUTPUTS Level 2 - 2 Bays

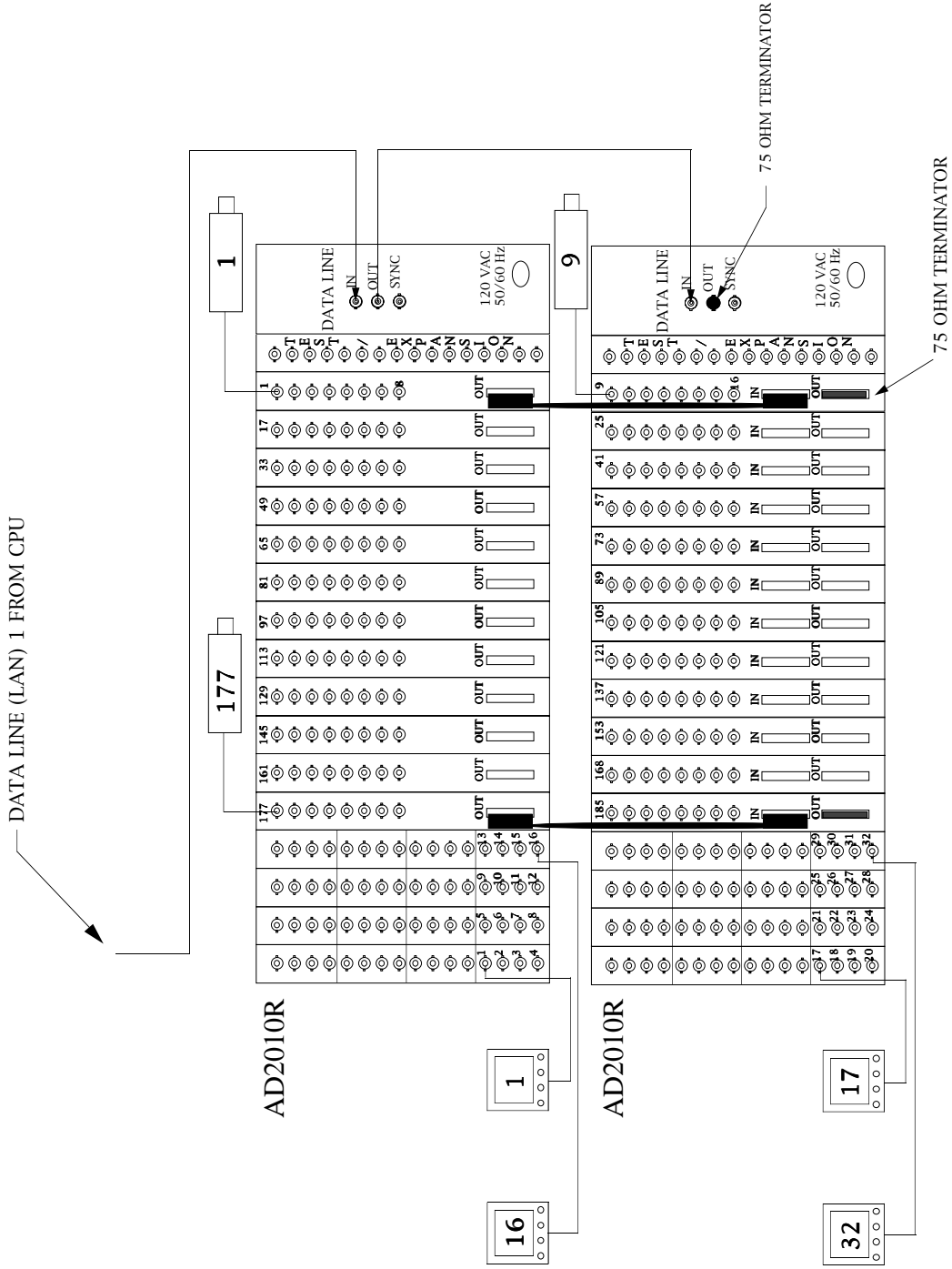

# 320 INPUTS X 32 OUTPUTS

## Level 2 - 3 Bays

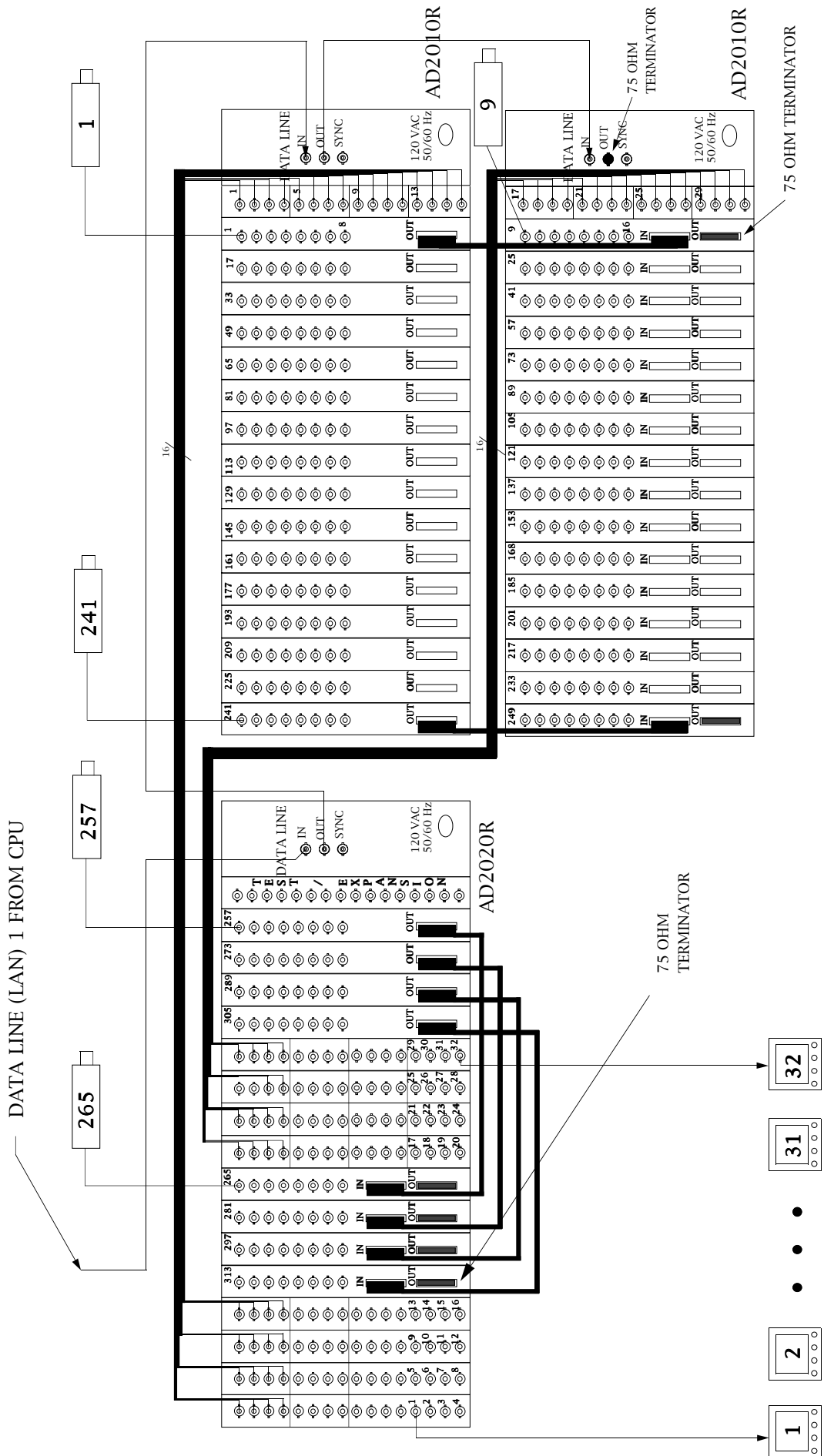

# 448 INPUTS X 32 OUTPUTS

## Level 2 - 4 Bays

DATA LINE (LAN) 1 FROM CPU

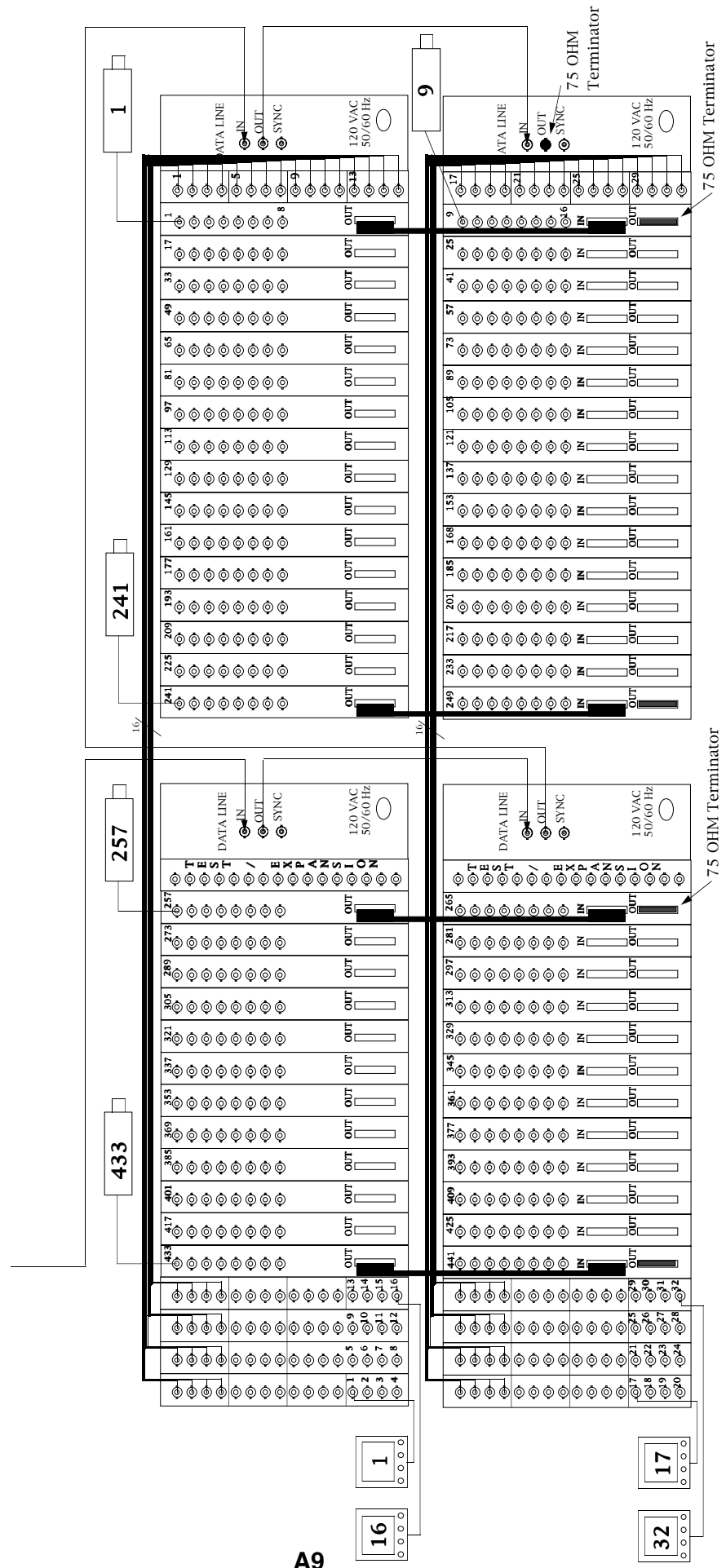

# 704 INPUTS X 32 OUTPUTS (Page 1)

## Level 2 - 6 Bays

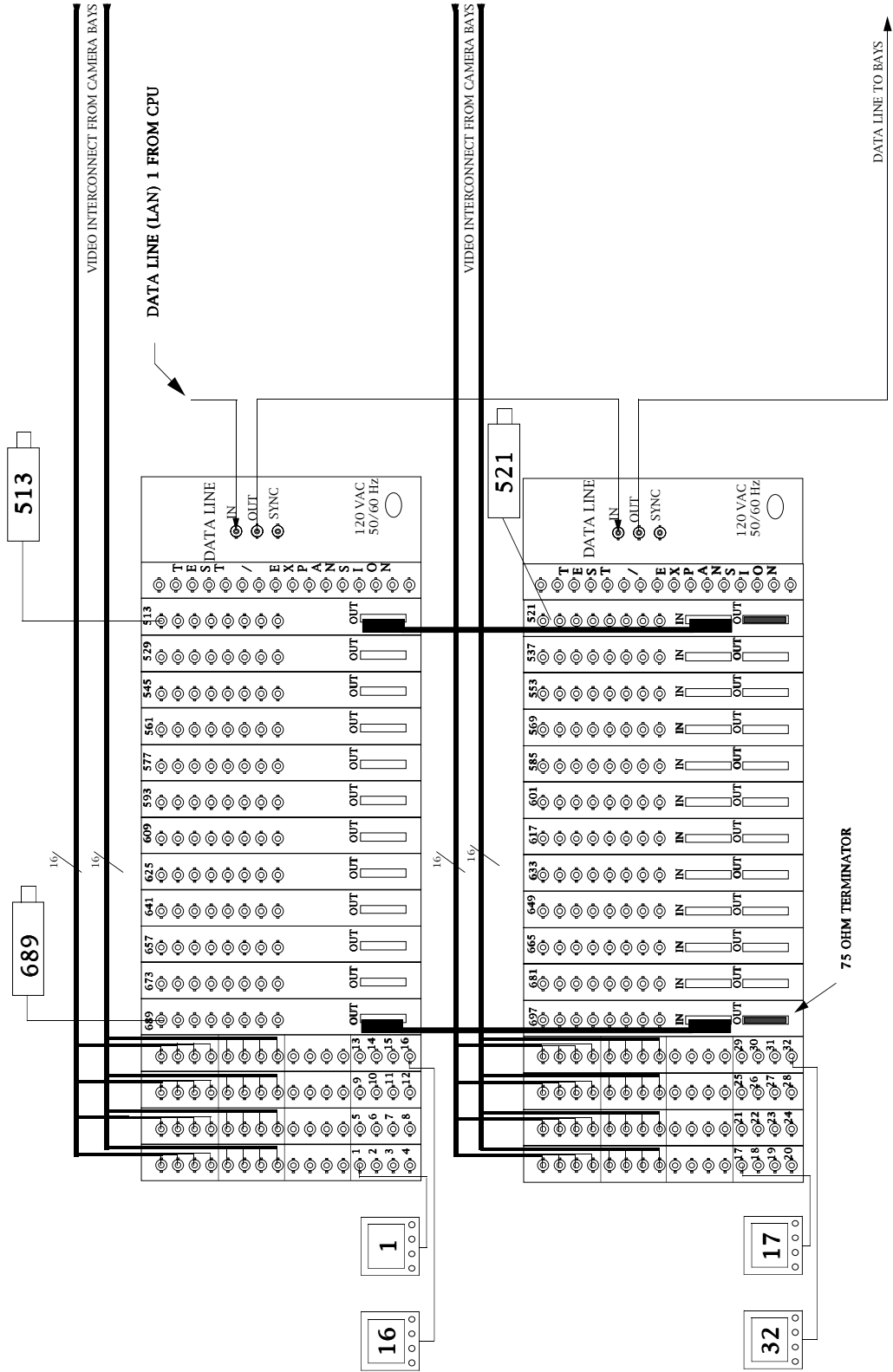

# 704 INPUTS X 32 OUTPUTS (Page 2)

## Level 2 - 6 Bays

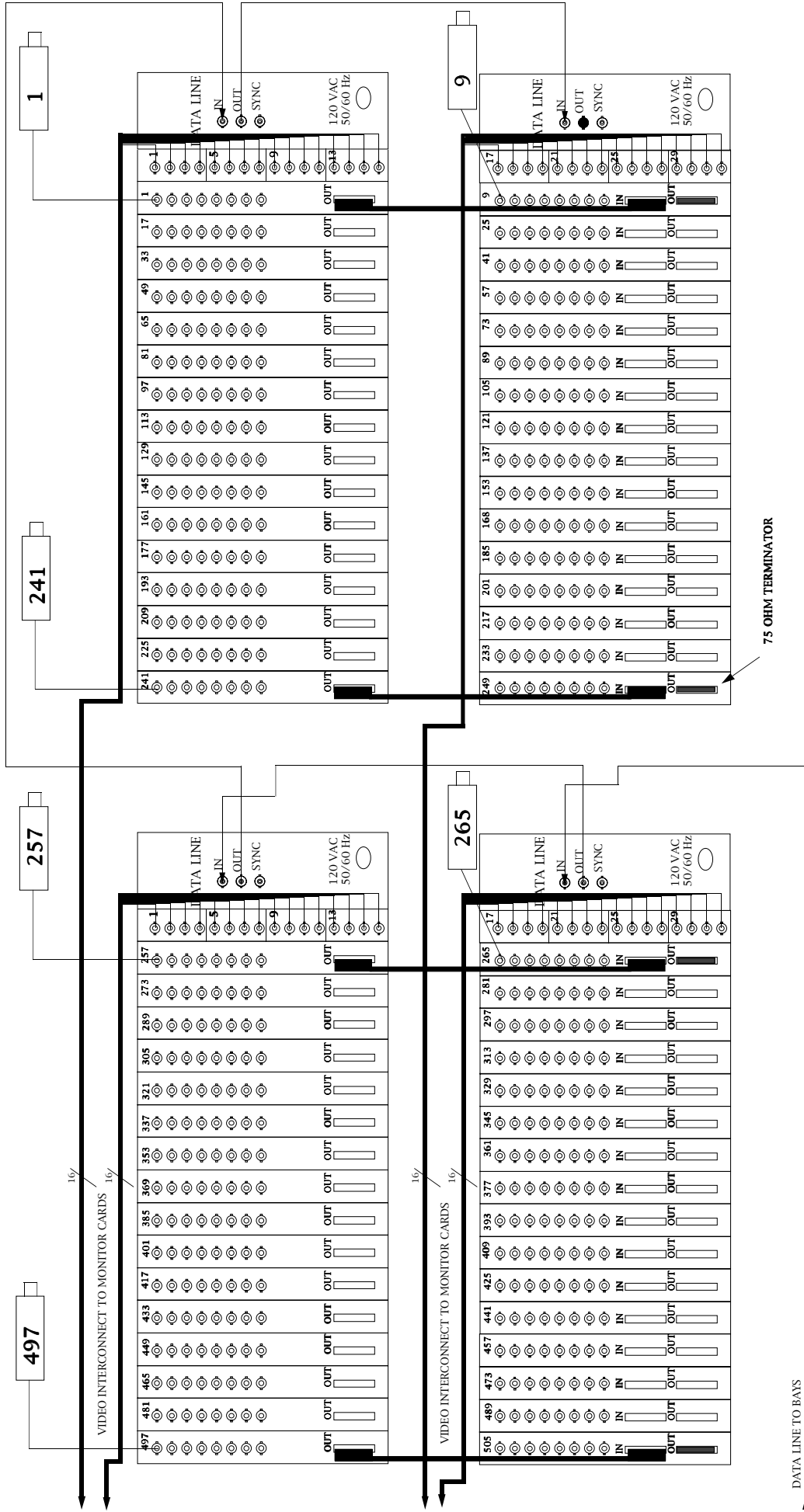

# 960 INPUTS X 32 OUTPUTS (Page 1)

## Level 2 - 8 Bays

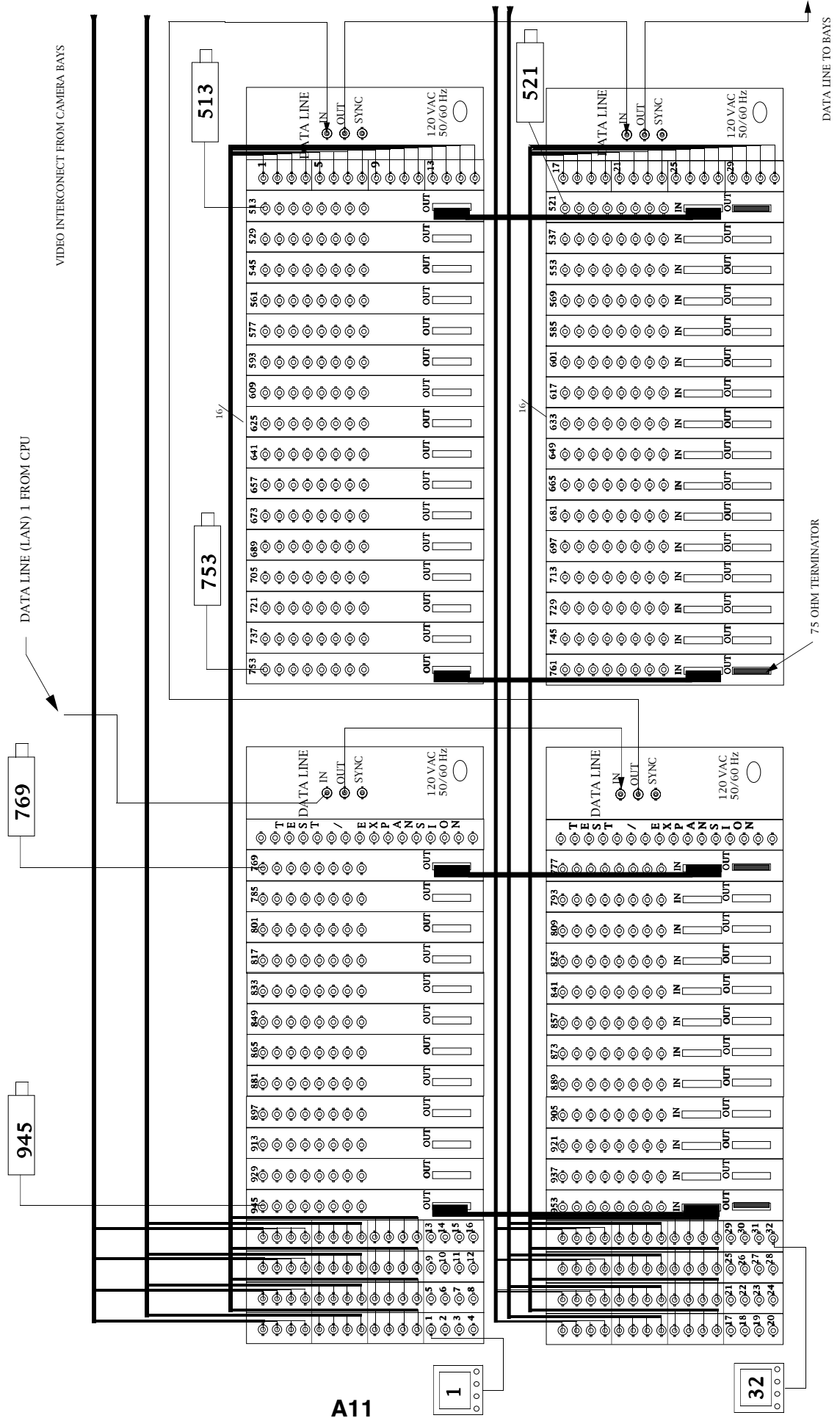



# 960 INPUTS X 32 OUTPUTS (PAGE 2)

## Level 2 - 8 Bays

VIDEO INTERCONNECT TO MONITOR CARDS

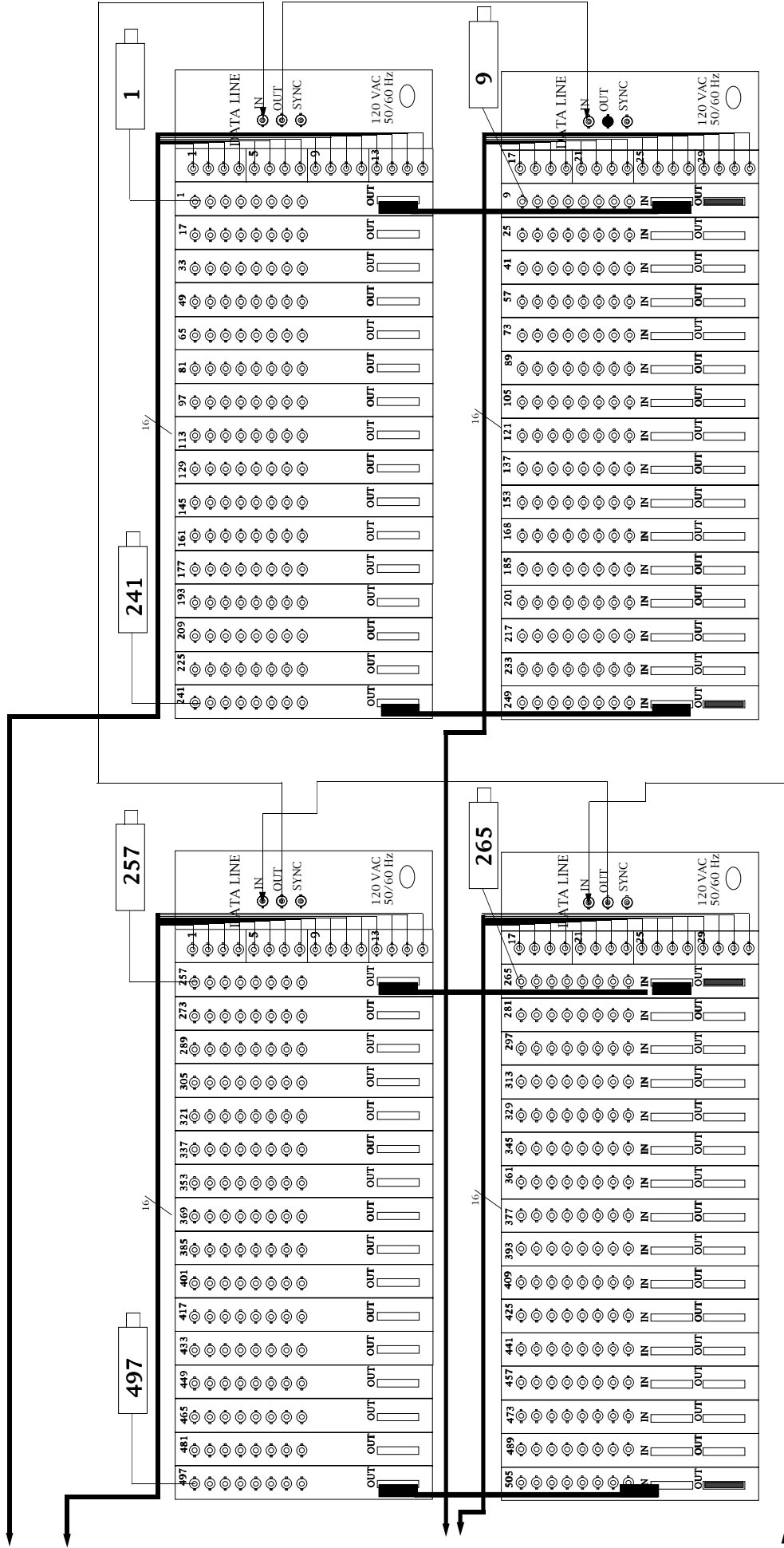

DATA LINE TO BAYS

# 192 INPUTS X 48 OUTPUTS

## Level 3 - 3 Bays

DATA LINE (LAN) 1 FROM CPU

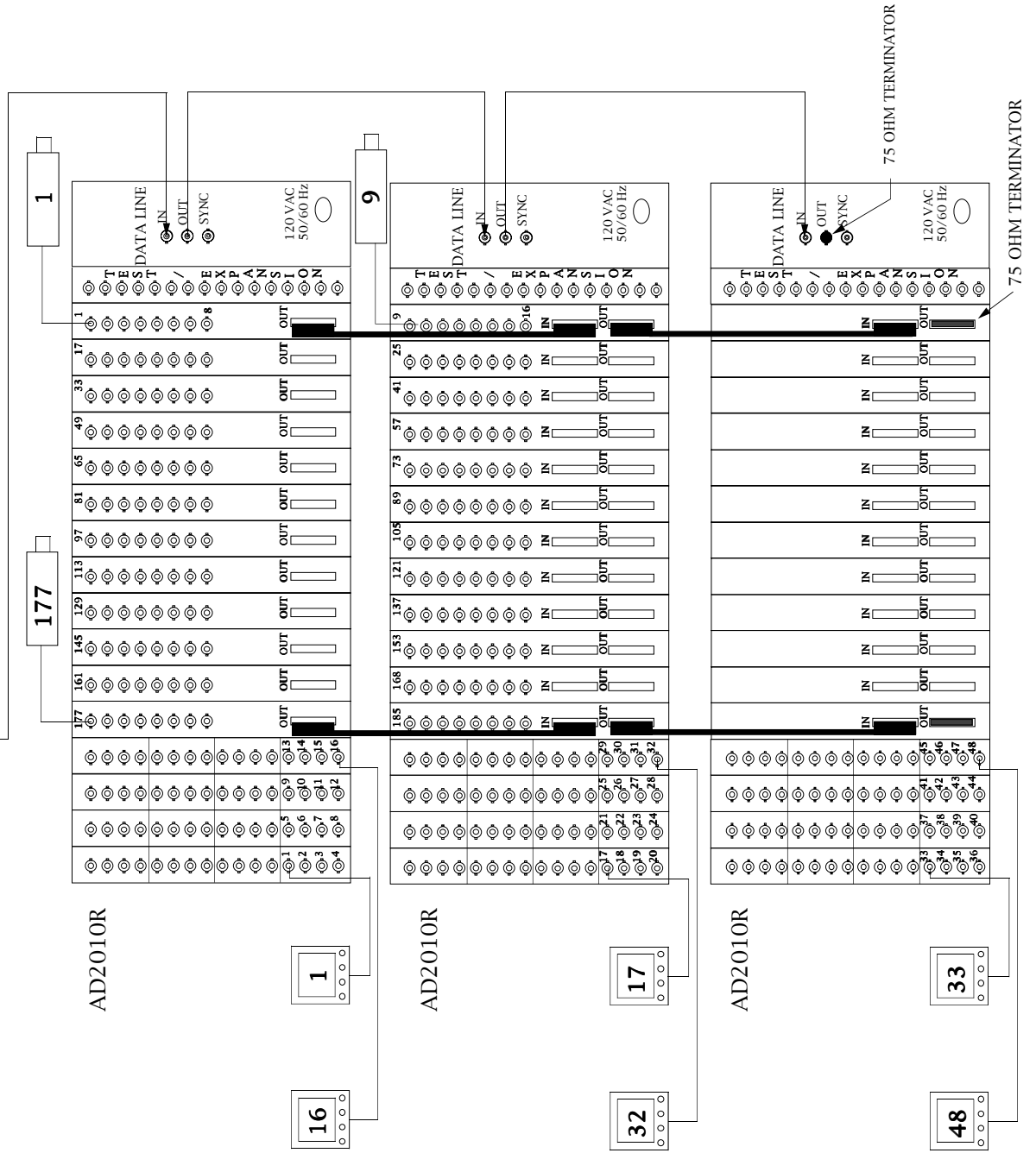

# 256 INPUTS X 48 OUTPUTS Level 3 - 4 Bays

DATA LINE (LAN)1 FROM CPU

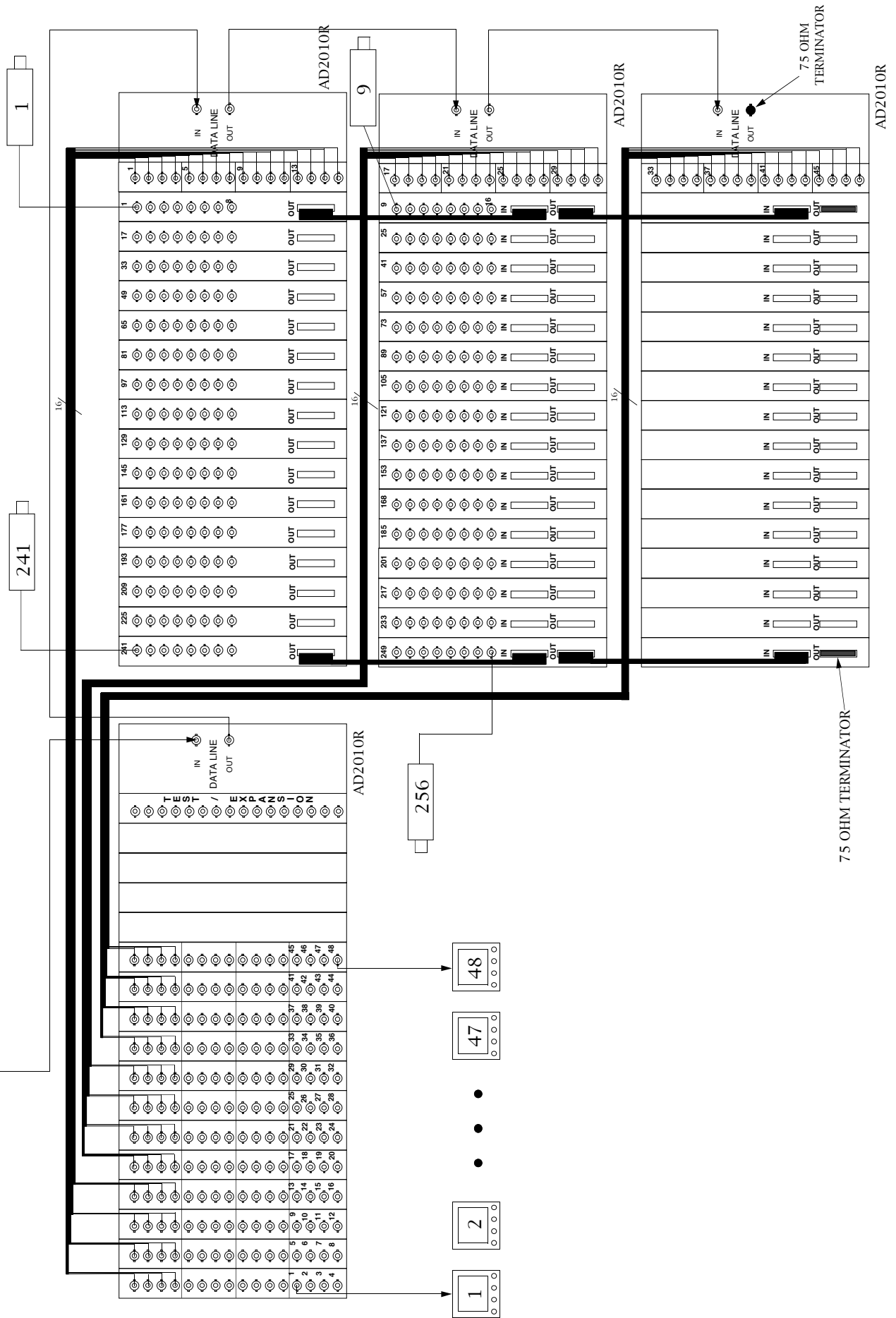



# 704 INPUTS X 48 OUTPUTS (Page 1) Level 3 - 9 Bays

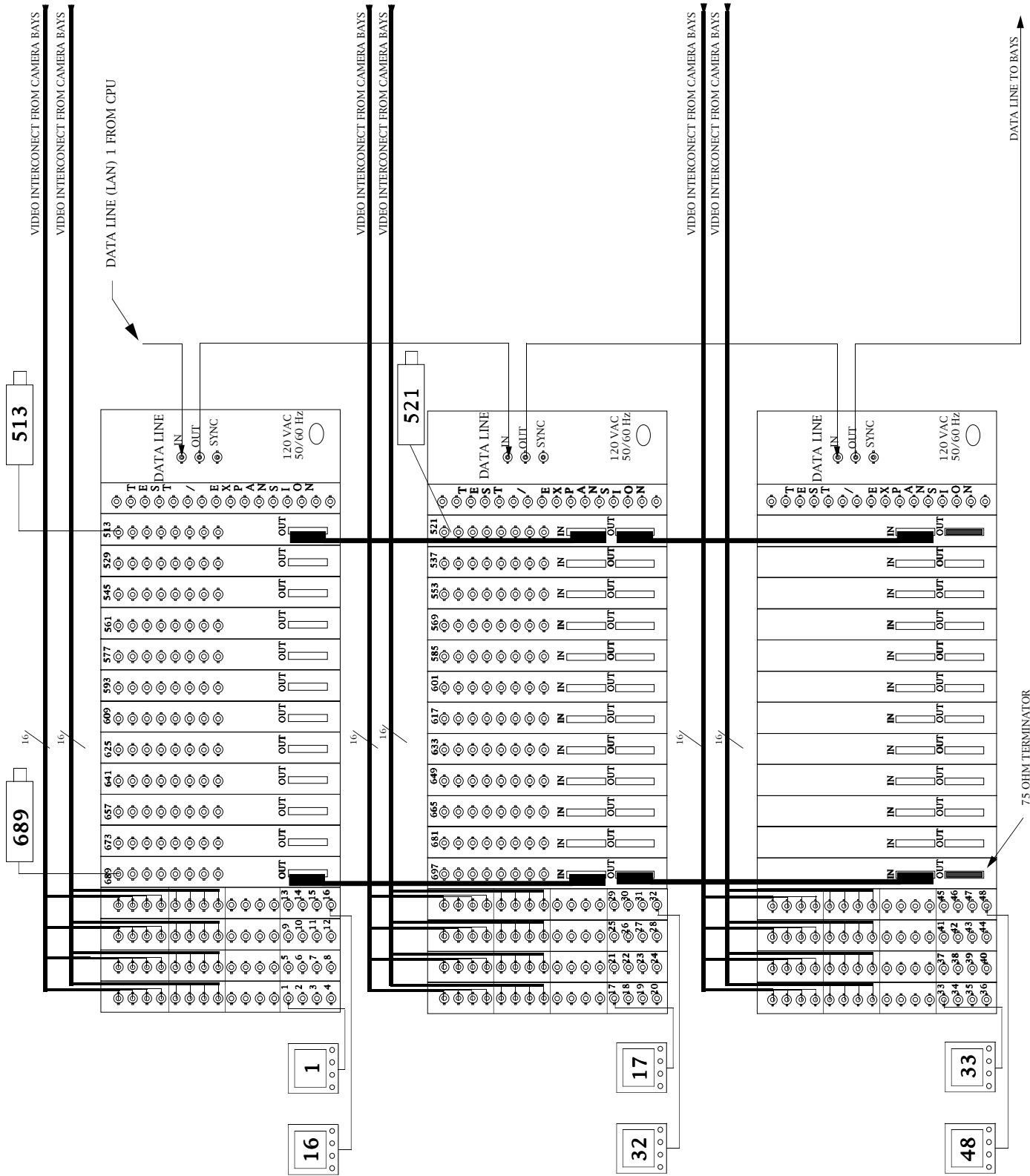

# 704 INPUTS X 48 OUTPUTS (Page 2)

## Level 3 - 9 Bays

497

VIDEO INTERCONNECT TO MONITOR CARDS 16/

VIDEO INTERCONNECT TO MONITOR CARDS 16/

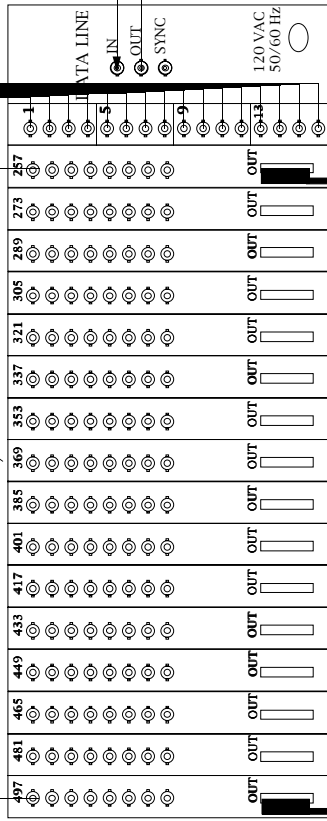

257

VIDEO INTERCONNECT TO MONITOR CARDS 16/

VIDEO INTERCONNECT TO MONITOR CARDS 16/

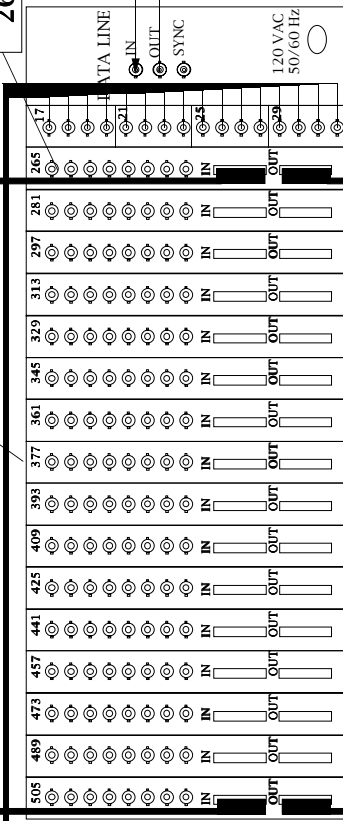

265

VIDEO INTERCONNECT TO MONITOR CARDS 16/

VIDEO INTERCONNECT TO MONITOR CARDS 16/

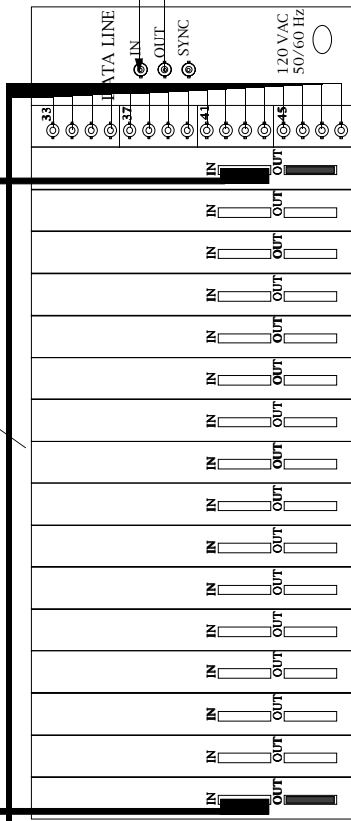

241

VIDEO INTERCONNECT TO MONITOR CARDS 16/

VIDEO INTERCONNECT TO MONITOR CARDS 16/

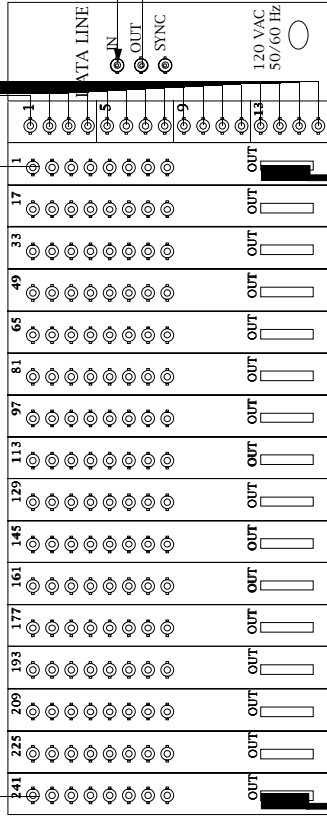

1

VIDEO INTERCONNECT TO MONITOR CARDS 16/

VIDEO INTERCONNECT TO MONITOR CARDS 16/

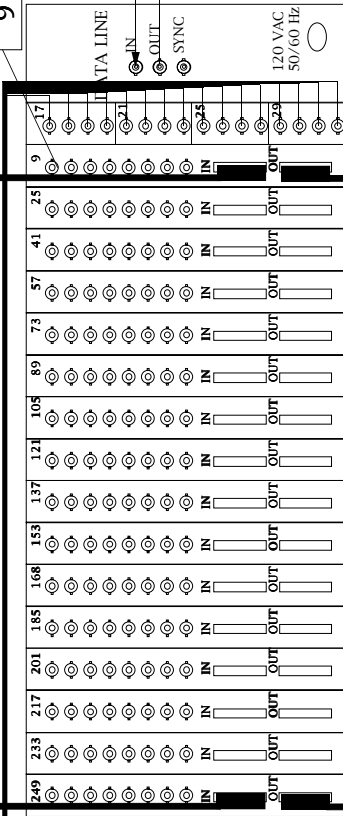

9

VIDEO INTERCONNECT TO MONITOR CARDS 16/

VIDEO INTERCONNECT TO MONITOR CARDS 16/

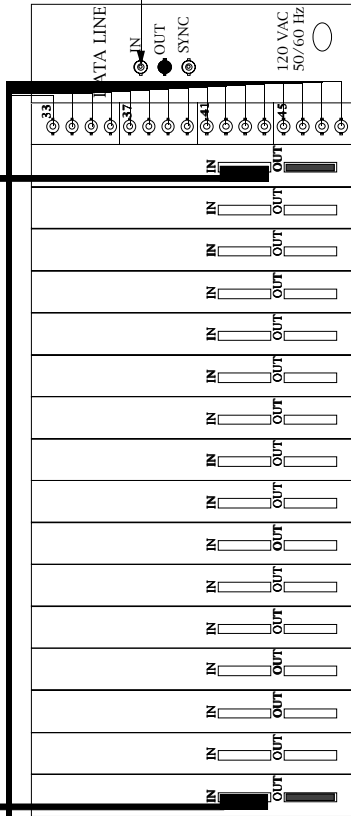

DATA LINE TO BAYS

# 768 INPUTS X 48 OUTPUTS (Page 1)

## Level 3 - 10 Bays

DATA LINE (LAN) 1 FROM CPU

VIDEO INTERCONNECT FROM CAMERA BAYS

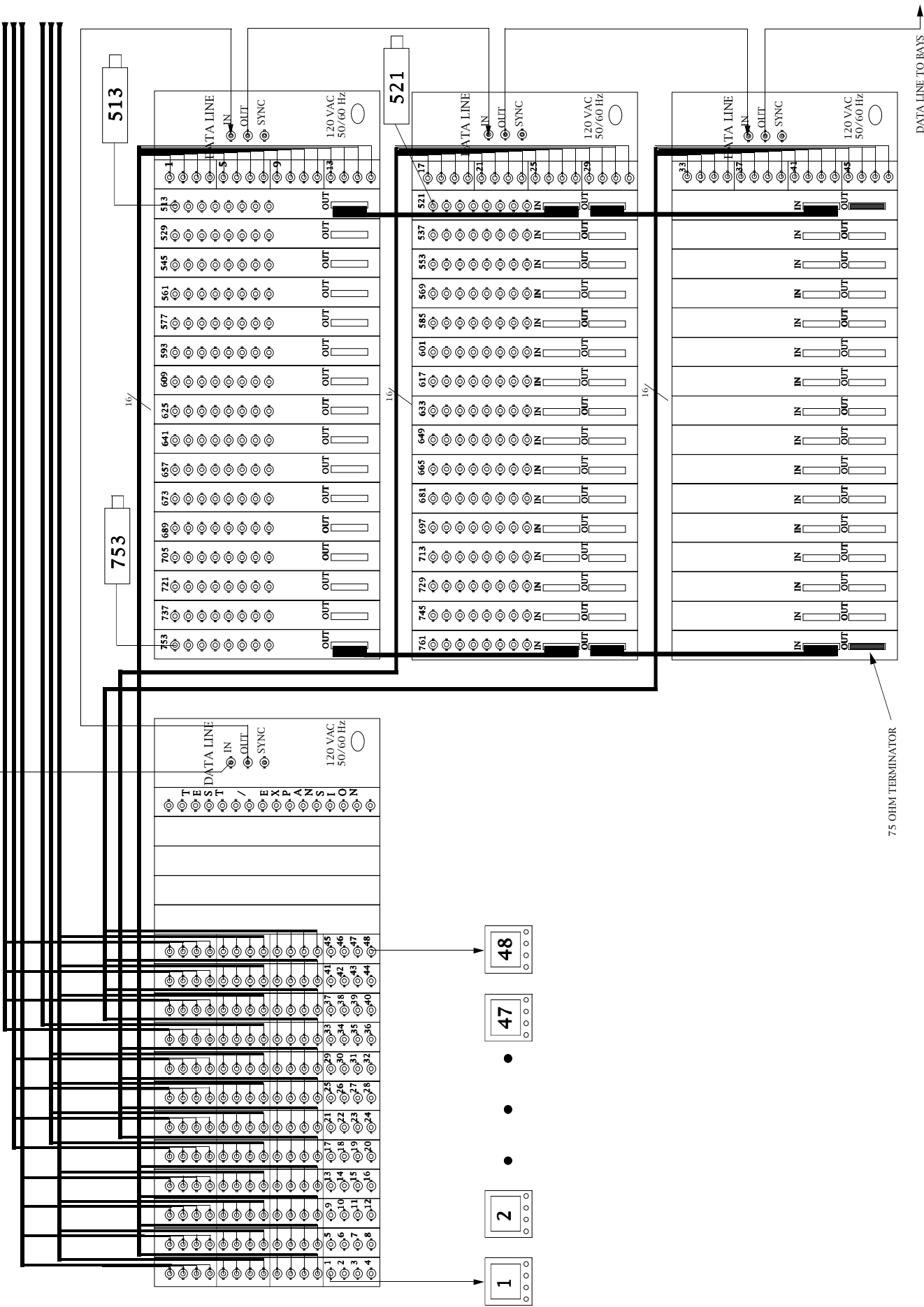

# 768 INPUTS X 48 OUTPUTS (Page 2)

## Level 3 - 10 Bays

VIDEO INTERCONNECT TO MONITOR CARDS

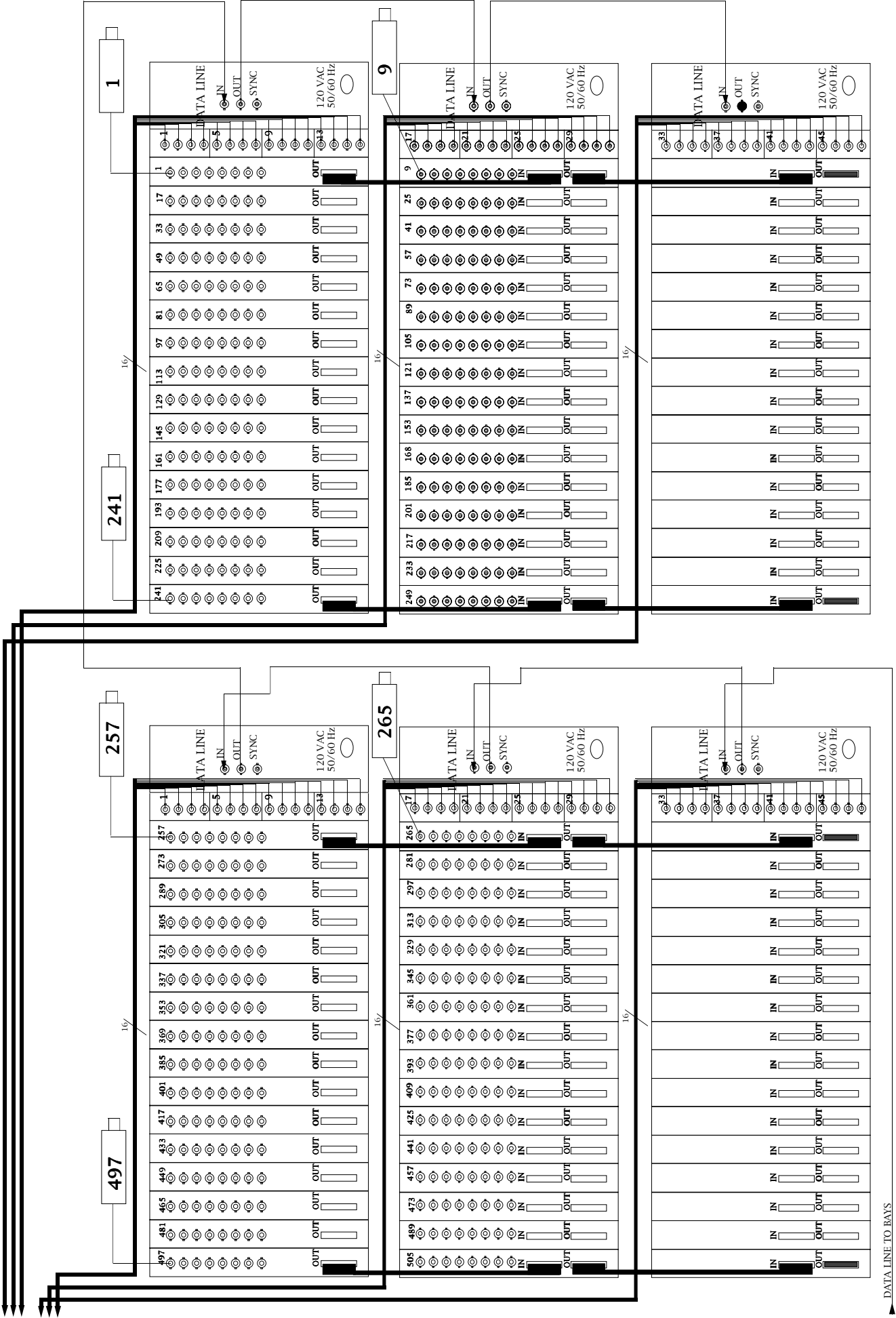

DATA LINE TO BAYS



# 64 INPUTS X 128 OUTPUTS

## Level 8 - 4 Bays

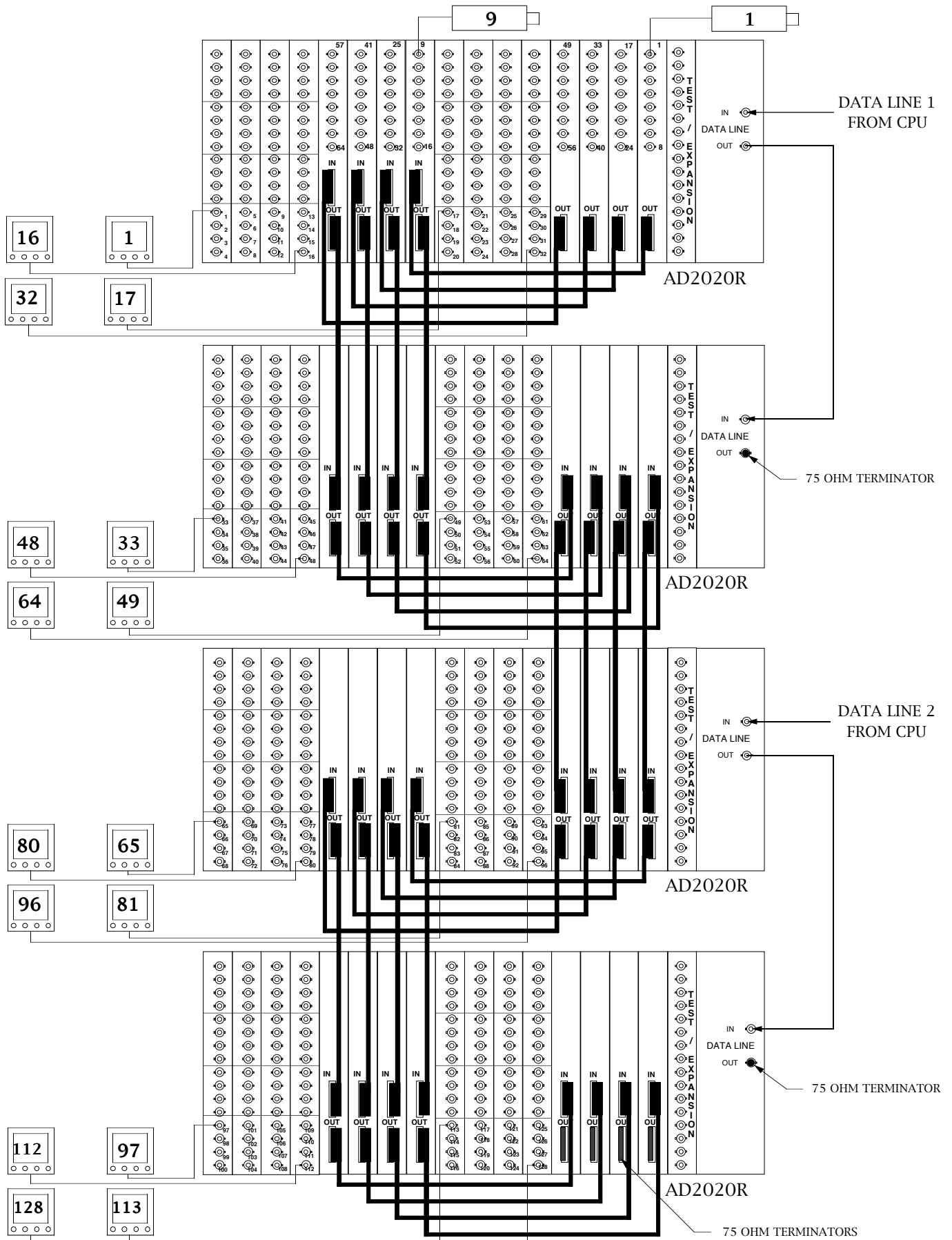



**256 INPUTS X 15 OUTPUTS**  
**With Video Loss Detection and Alarm Outputs**  
**Level 1 - 1 Bay**

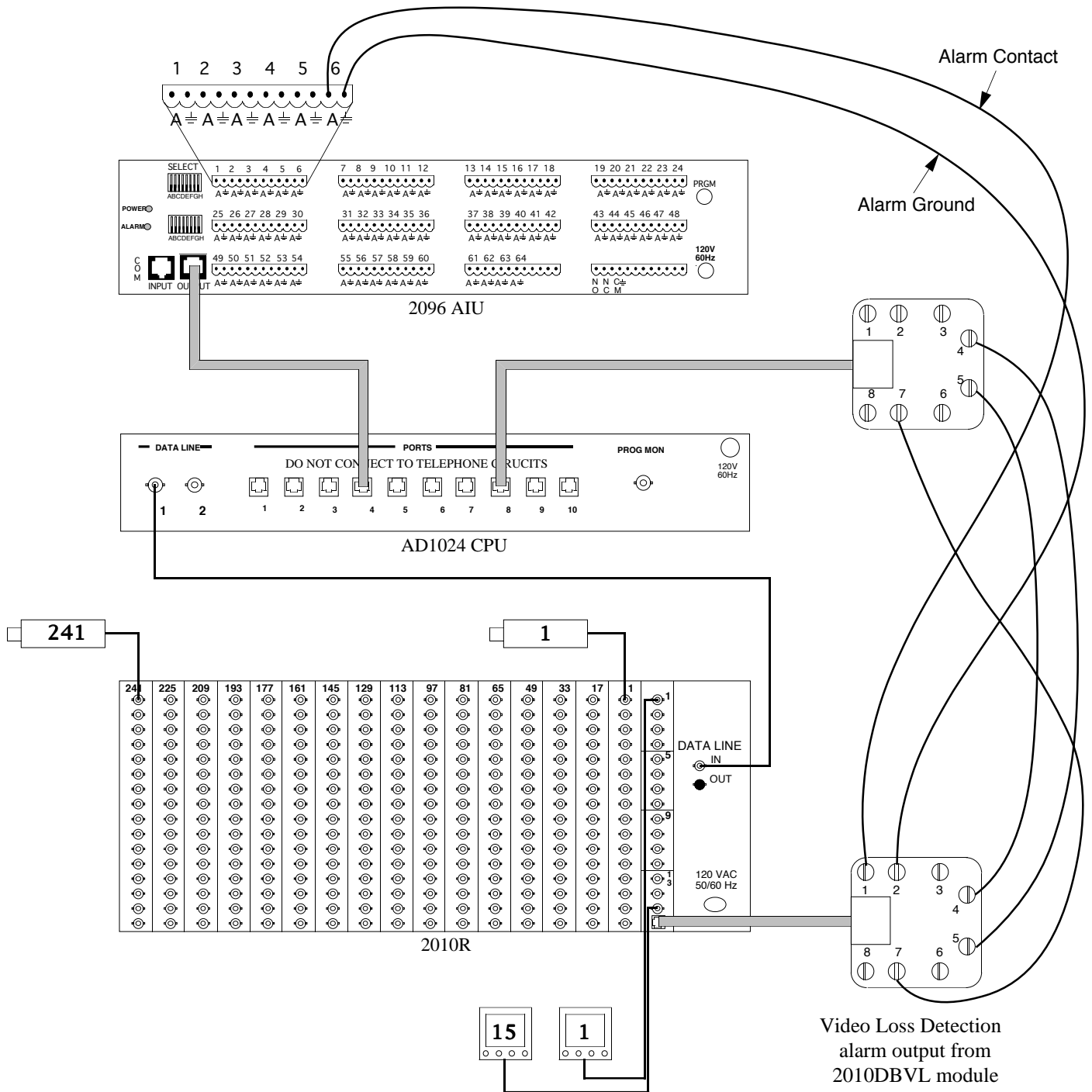

Connection shown where distance between 2010 Bay and AD1024 CPU is over 7 feet, and alarm output from 2010DBVL is provided to 2096 Alarm Interface Unit.



# 448 INPUTS X 15 OUTPUTS - With Video Loss Detection Level 1 - 2 Bays with AD1981 Port Expander

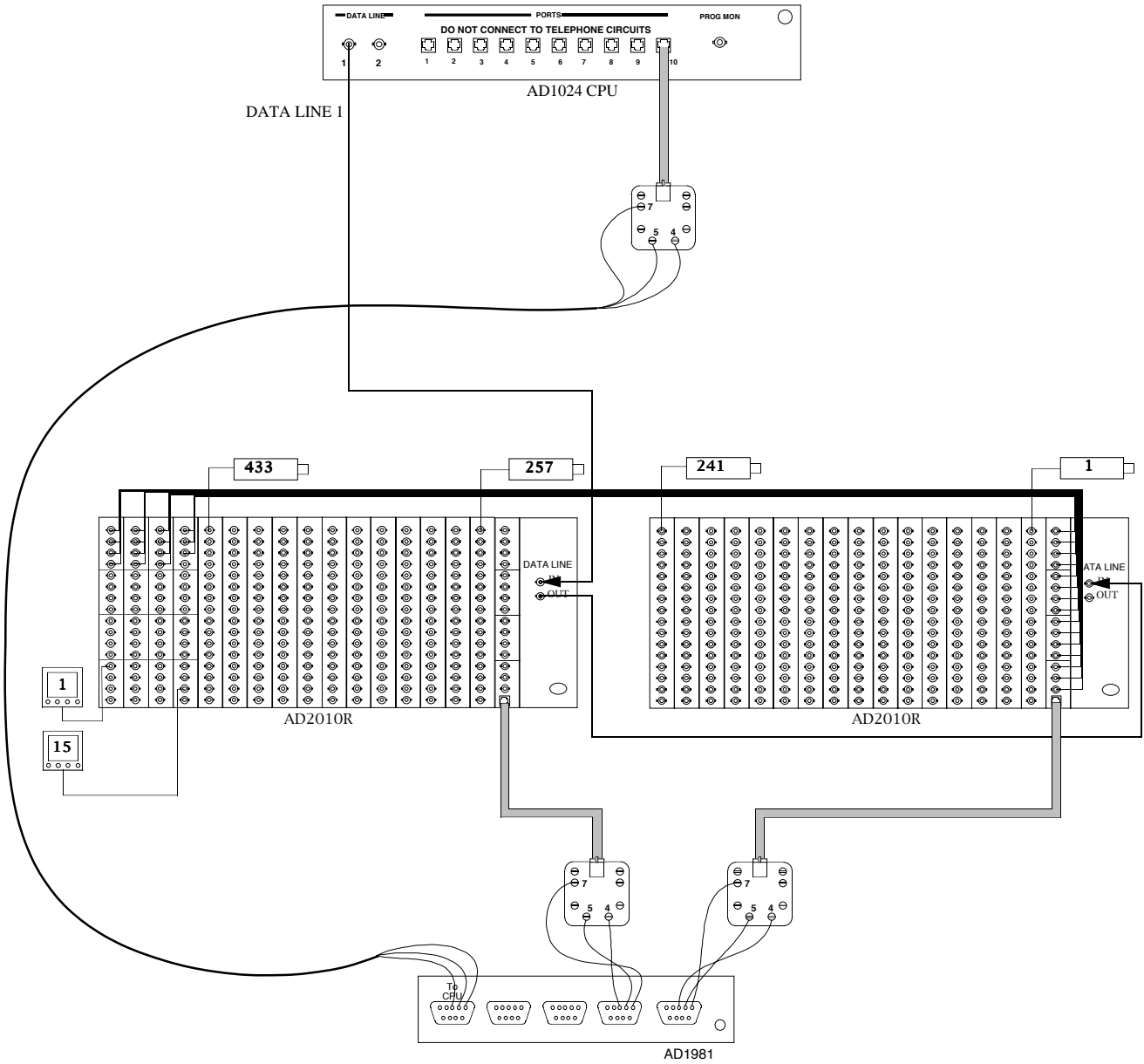

Video Interconnections (Page 1)  
Input Bays to Video Output Modules  
 Outputs 1 - 4

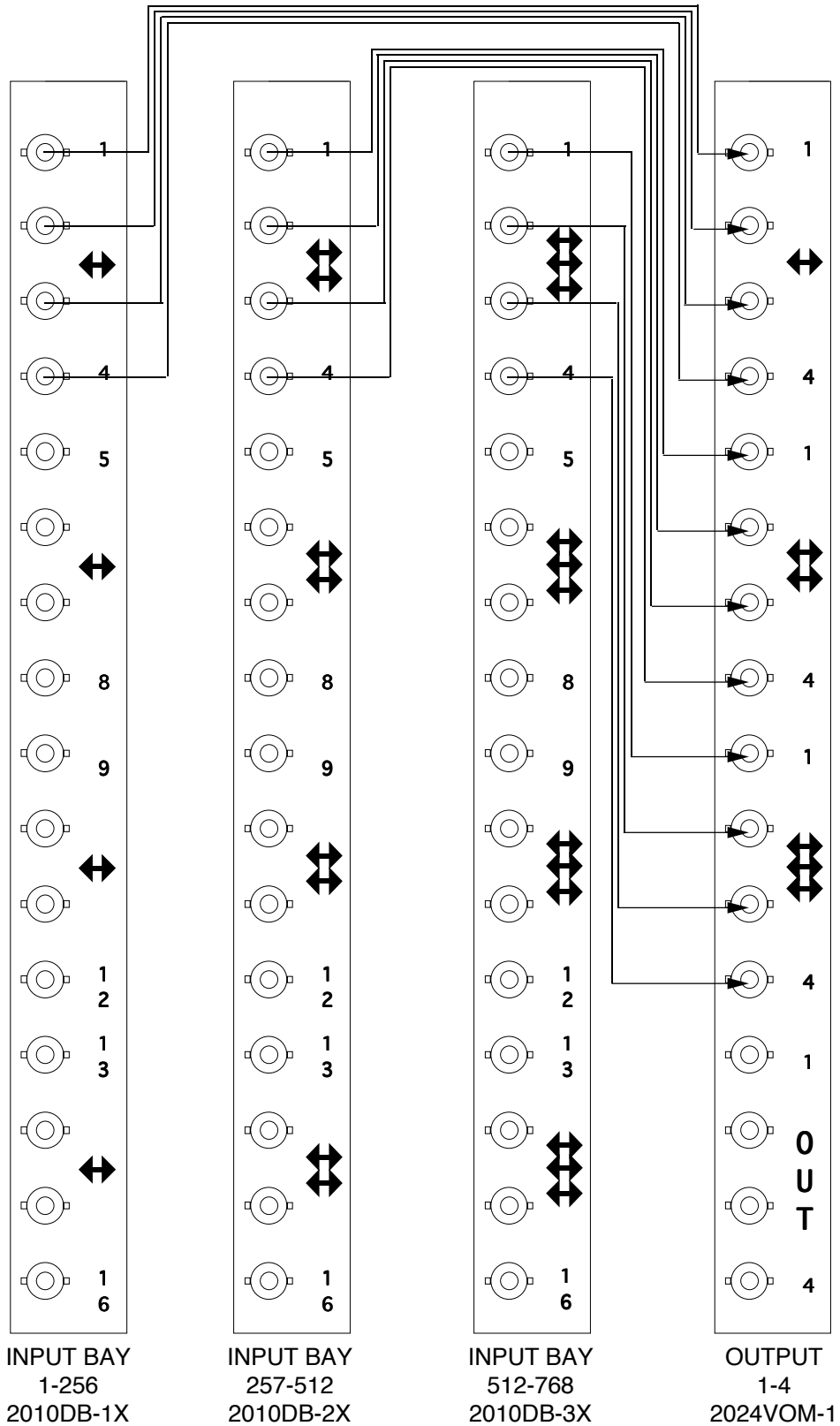

Video Interconnections (Page 2)  
Input Bays to Video Output Modules  
 Outputs 125 - 128

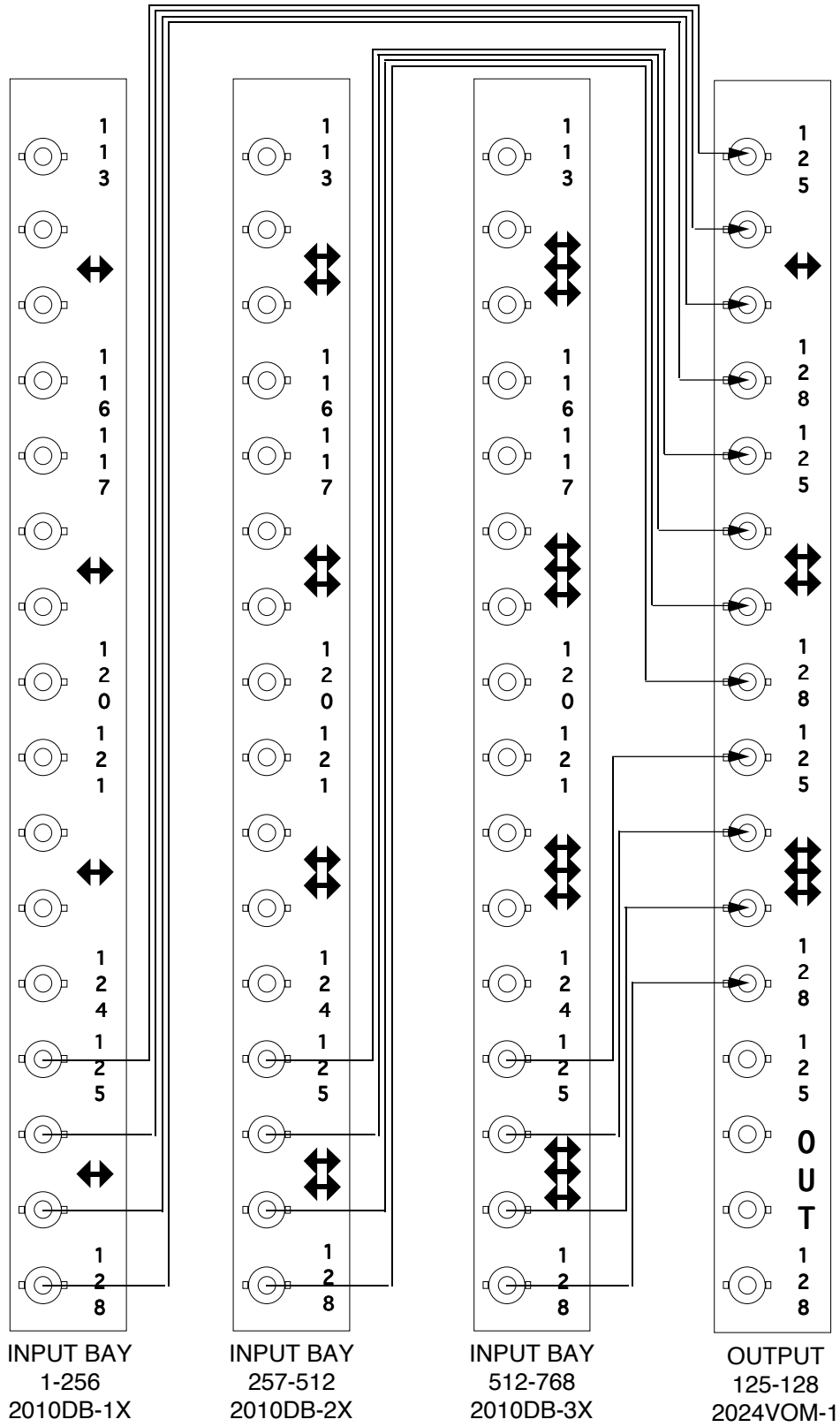





# DECLARATION OF CONFORMITY

According to ISO/IEC Guide 22 and EN45014

**Manufacturer's Name:** Sensormatic Electronics Corporation

**Manufacturer's Address:** 1 Blue Hill Plaza  
2<sup>nd</sup> Floor  
Pearl River, New York, 10965 USA

**Declares, that the product listed below:**

Name/Type: MegaPower II Matrix Switching System  
Model Number: ADS1024X – all versions

**consisting of:**

Name/Type: Bays  
Model Numbers: AD2010R-1  
AD2020R-1

Name/Type: Modules  
Model Numbers: AD2010PS-1 (Power Supply)  
AD2016AVIM (Video Input)  
AD2024AVOM (Video Output)  
AD2010DB (Data Buffer)

**complies with all applicable directives as demonstrated by conformance to the following Product Specifications:**

Safety: EN 60950: 1992  
EMC: EN 50130-4: 1995  
EN 55022: 1994 , Class B  
EN 61000-3-2: 1995  
EN 61000-3-3: 1995  
EN 61000-4-2: 1995  
EN 61000-4-3: 1996  
EN 61000-4-4: 1995  
EN 61000-4-5: 1995  
EN 61000-4-6: 1996  
EN 61000-4-11: 1994

**Supplementary Information:**

The products herewith comply with the requirements of the Low Voltage Directive, 73/23/EEC as amended by 93/68/EEC, and the EMC Directive, 89/339/EEC as amended by 93/68/EEC.

Pearl River, NY, USA 1 October, 2000



Harold D. Johnson, Ph.D.  
Director of Engineering

**SPECIFICATIONS:**

**Supply Voltage:** AD1024R: 120 VAC, 50/60 Hz, 50 W  
ADS1024RX: 230 VAC, 50/60 Hz, 0.50 A

**Temperature:** 0°C - 60°C (32°F - 140°F)

**Humidity:** Relative humidity between 0% and 95% non-condensing

**Mounting:** Free standing or rack-mount

**Size:** 19" W x 10.5" H x 18.5" D - Rack  
17.5" Desk Width

**Weight:** 55 lbs.

**Finish:** Black

Sensormatic Video Systems Division  
One Blue Hill Plaza  
Pearl River, New York, 10965  
(845) 624-7600  
Technical Support Center: 800-442-2225  
FAX: (845) 624-7685