

SpeedDome® Ultra Indoor Housing and Indoor Vandal-Resistant Housing

Installation Guide

Models: ADSDUPIHC, ADSDUPIHS, ADSDUPVRC, ADSDUPVRS

For Indoor Use Only!

Figure 1. SpeedDome Ultra housings

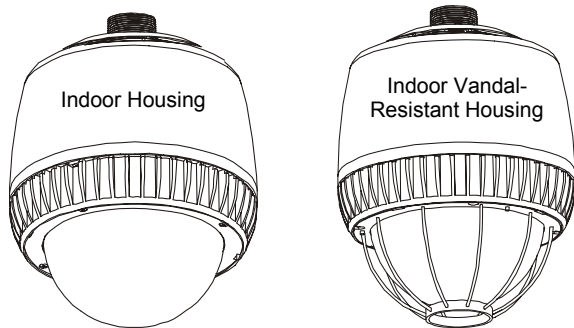

About this Guide

This guide explains how to prepare the indoor housing for installation to a mounting structure and assumes that the mounting structure is in place and that data and power cables have been pulled to the installation site.

This guide does not explain:

- Cable requirements,
- Camera installation, or
- How to install the mounting structure.

For this information, see instructions shipped with the camera dome or mounting structure.

About the Indoor Housing

The indoor housing (Figure 1) is used to attach the SpeedDome Ultra camera dome to an indoor mounting structure. This housing can attach to mounting structures shown in Table 1.

Table 1. Indoor mounting Structures

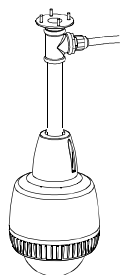
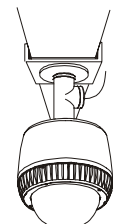
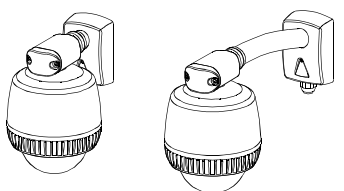
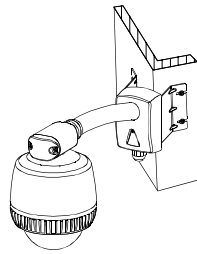
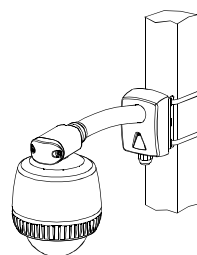
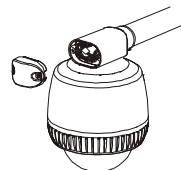
RHOPN Pendant Mount	
RHIUIBM I-Beam Mount	
RHOSW/RHOLW Short/Long Wall Mount	
RHOWCA Corner Mount	
RHOWPA Pole Mount	
ROENDC End Cap	

If You Need Assistance...

Contact your sales representative.

Warnings and Cautions

Please review the following warnings and cautions before you begin installation or service.

WARNINGS



WARNING!

ALWAYS USE:

- Proper safety equipment for the location and type of installation.
- Proper lift equipment to reach the installation.
- Safety features of the lift equipment.

BE SURE:

- Electrical power is not connected to the dome when connecting wires. Dome will move when power is applied.
- Electrical power is not connected to nearby fixtures that you might touch during installation.



WARNING!

The camera dome used in this housing runs on 24Vac. DO NOT connect line voltage to this dome.

Worldwide power requirements: A certified limited power source is required.

North America power requirements: This device is intended to be supplied from a Class 2 power supply.

This installation should be made by a qualified service person and should conform to all local codes.



WARNING!

DO NOT install this housing in hazardous areas where highly combustible or explosive products are stored or used.

CAUTION

There are two boxes: one for the indoor housing, and one for the bubble assembly. Protect the bubble assembly by leaving it in its box until you are ready to install it.

Equipment Required for Installation

Parts Supplied

- Standard housing assembly 0201-0007-01
- Vandal housing assembly 0201-0007-02
- Standard bubble assembly 0400-1402-01/-02
- Vandal bubble assembly 0404-0083-01/-02
- Tamperproof drive 1400-0149-01 (supplied with bubble)

Purchase or Supply Separately

- RUIOB Indoor I/O Board or RUPTB Pigtail Board

Tools Required

- 6mm (.25in) fixed-handle nut driver for Torx bit
- Small screwdriver for tightening connectors
- Wire cutters and strippers

Installation



WARNING: Ensure that ac power and electrical signals are off before beginning this procedure.

1. See instructions supplied with the SpeedDome Ultra housing and eyeball assembly for how to prepare it for installation in the housing.
2. Connect the housing and eyeball assembly to the base (Figure 2).
 - a. Align recessed dimple on cap of dome with logo visible on environmental PC board.
 - b. Mate the housing and eyeball assembly to the base and turn it clockwise until you hear a click.

Figure 2. Attaching dome to the base in an indoor housing (align protrusions on cap and base, then twist to lock)

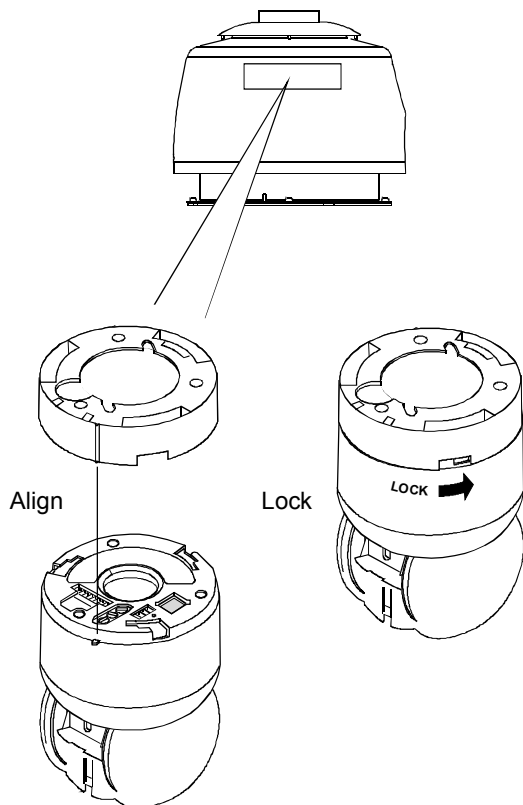

Referring to Figure 3:

3. Remove the bubble assembly from the package and ensure the bubble is clean and free of debris.
4. Attach the coiled lanyard from the bubble to the threaded stud on the indoor housing using the thumbnut supplied.
5. Attach trim bubble assembly.
 - a. Discard the red “CAUTION: Remove slot covers” tag. There is no need to remove the slot covers for indoor applications.
 - b. Align the key on the inside of the bubble assembly with the detent on the edge of the housing.

CAUTION: To maintain the integrity of the gasket seal between the housing flange and the trim ring, do not let the lanyard get caught between these two pieces as you secure the bubble assembly to the housing.

 - c. Use the drive (taped inside bubble) to tighten the four tamper-proof screws on the bubble assembly. To compress the gasket evenly, tighten each screw in clockwise formation until slight resistance is felt, then retighten each screw again in clockwise formation until all screws are evenly tight.
6. See instructions for the mounting structure for how to attach the housing assembly.

Figure 3. Attaching bubble assembly

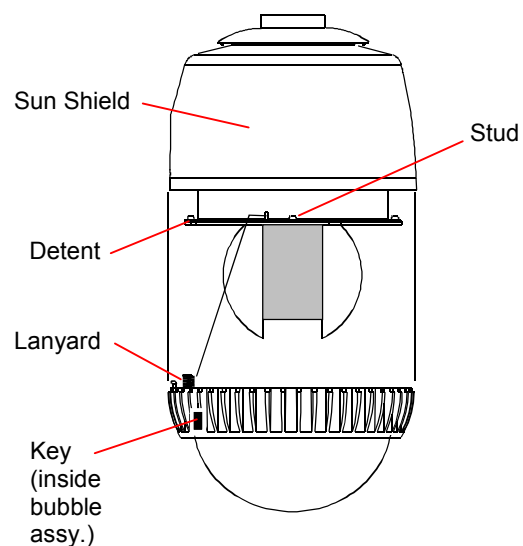

Parts List for Authorized Users

Only parts below can be ordered, and only by authorized users. To become authorized, contact your sales representative.

Table 2. Parts list

1	Bubble/Trim Assy. Clear	0400-1402-01
2	Bubble/Trim Assy. Smoked	0400-1402-02
3	Bubble/Trim Assy. Clear Vandal	0404-0083-01
4	Bubble/Trim Assy. Smoked Vandal	0404-0083-02
5	Housing Assembly Indoor	0201-0007-01
6	Housing Assembly Indoor Vandal	0201-0007-02
7	T20 Tamperproof Torx Bit	1400-0149-01